

Godox

THINKLITE

TT680-N

Nikon i-TTL Compatible Flash

INSTRUCTION MANUAL
说明书

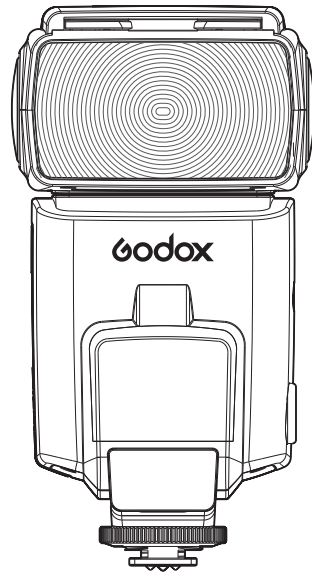

中英文双语 / Chinese English Bilingual

Thank you for purchasing a GODOX product.

The GODOX TT680-N camera flash applies to Nikon DSLR cameras and is compatible with i-TTL autoflash. It supports Multi/Stroboscopic flash function, as well as auto and manual zoom function with a flash coverage of 24 to 105 mm. With this i-TTL compatible flash, your shooting will become simpler. You can easily achieve a correct flash exposure even in complex lighting-changing environment.

Contents

1. Getting Started and Basic Operation	03
2. Using Flash	06
3. Reference	13

Conventions used in this Manual

• The operation procedures in this instruction manual assume that both the camera and camera flash's power switches are ON.

• Reference page numbers are indicated by (p.**).

• This instruction manual uses the following alert symbols:

▲ : The Caution symbol indicates a warning to prevent shooting problems.

📌 : The Note symbol gives supplemental information.

Nomenclature

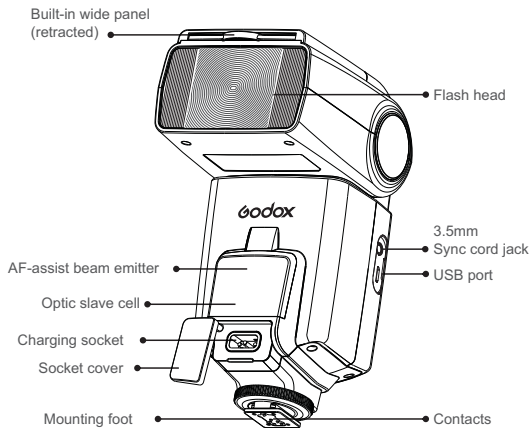

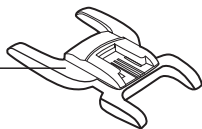

Mini stand



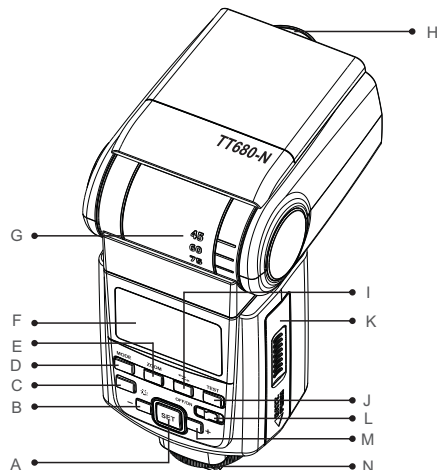
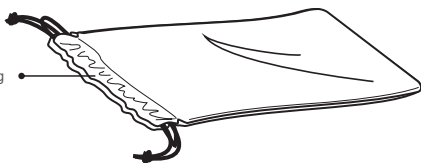



Protecting bag

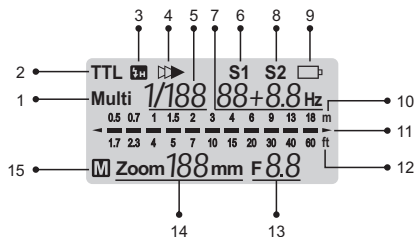

- A. < SET >
Set button
- B. < - >
Go to next downwards
- C. <  >
LCD panel illumination
Custom function setting
- D. < MODE >
Flash mode selection
- E. < ZOOM >
Zoom button
- F. LCD panel
- G. Bounce angle
- H. Catchlight panel
- I. <  >
Off camera flash mode setting button
- J. Flash-ready indicator
- K. Battery compartment cover
- L. Power switch
- < OFF >: Power off
- < ON >: Power on
- M. < + >
Go to next upwards
- N. Locking screw

LCD Panel



1. < M/Multi >
Manual flash/Multi flash
2. < TTL >: i-TTL autoflash
3. : High-speed sync (FP flash)
4. : Second-curtain sync
5. Manual flash output level
6. S1 slave triggering mode
7. Multi flash count
Multi flash frequency
Manual flash output in 1/3rd stop increments
- FEC: Flash exposure compensation amount
8. S2 slave triggering mode
9. <  > Low battery
10. Indicator (meters)
11. Flash range scale
12. Indicator (feet)
13. Aperture
14. Zoom focal length
15. <  > Manual zoom

Getting Started and Basic Operation

Installing the Batteries	03
Attaching to the Camera	04
Turning on the Power Switch	04
Fully Automatic Flash Shooting	04
Using i-TTL Autoflash in the Shooting Modes	05

▲ Cautions for firing continuous flashes

- To avoid overheating and degrading the flash head, do not fire more than 20 continuous flashes. After 20 continuous flashes, allow a rest time of at least 10 min.
- If you fire more than 20 continuous flashes and then fire more flashes in short intervals, the inner overheating prevention function may be activated to make the recycling time about 8 to 20 sec. If this occurs, allow a rest time of about 15 min, and the flash will then return to normal.

Installing the Batteries

Install four size-AA batteries.

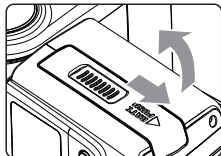

1. Open the cover.
 - Use your thumb to press the battery compartment cover, and then slide it to open the cover.

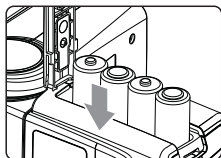

2. Install the batteries.
 - Make sure the + and - battery contacts are properly oriented as shown in the compartment.

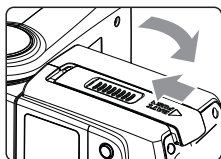

3. Close the cover.
 - Slide the battery compartment cover as shown by the arrow to close it.

Recycling Time and Flash Count (with size-AA alkaline batteries)

Recycling Time	Flash Count
Approx. 0.1-5 sec	Approx. 100-700

Based on new size-AA alkaline batteries.

- ▲ • Using size-AA batteries other than the alkaline type may cause improper battery contact due to the irregular shape of the battery contacts.
- If you change the batteries after firing many flashes continuously, be aware that the batteries might be hot.

- 🔋 • Use a new set of four batteries of the same brand. When replacing the batteries, replace all four at one time.
- Size-AA Ni-MH or lithium batteries can also be used.

Attaching to the Camera

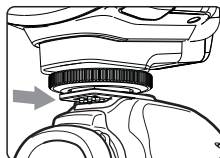

1. Attach the Camera Flash.
 - Slip the camera flash's mounting foot into the camera's hot shoe all the way.

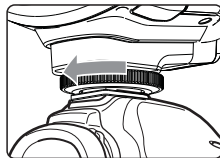

2. Secure the Camera Flash.
 - Rotate the locking screw on the mounting foot until it locks up.

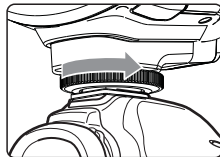

3. Detach the Camera Flash.
 - Rotate the locking screw on the mounting foot until it is loosened.

Turning on the Power Switch

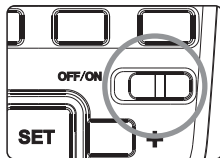

1. Set the power switch to <ON>.
 - Camera flash starts charging.

▲ If < > blinks on the LCD panel, the battery power is low and the camera flash stops charging. In this case, the <ZOOM> button is disabled. Please change the batteries immediately.

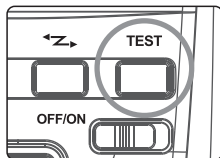

2. Check that the flash is ready.
 - The flash-ready indicator turns red, indicating that the camera flash is fully charged and ready for firing.
 - Pressing <TEST> button will fire a test flash.

About Auto Power Off

To save battery power, the power will be off automatically after a certain period of idle use.

- The flash will enter sleep mode after approx. 90 seconds of idle use when being attached to the camera.
- Setting as off camera mode, namely, the S1/S2 slave triggering mode, the flash will enter sleep mode after approx. 60 minutes (adjustable, 30 minutes by default).

To turn on the camera flash again, press the camera's shutter button halfway. Or press the camera flash's test firing button.

- ▲ When the Power Switch is set to ON and the flash power is off automatically after a certain period of idle use, power consumption exists and long-time power discharge damages batteries. Therefore, make sure to shut down the flash power by setting the Power Switch to OFF if the flash is not used for long.

Fully Automatic Flash Shooting

When you set the camera's shooting mode to <P> (Program AE) or <AUTO> (Full Auto), i-TTL fully automatic flash will make it as easy as normal AE shooting in the <P> and <AUTO> modes.

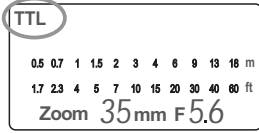

1. Set the Camera Flash to i-TTL auto flash mode.
 - Press the <MODE> button so that <TTL> is displayed.



2. Focus the subject.
 - Press the shutter button halfway to focus.
 - The shutter speed and aperture will be displayed in the viewfinder.
 - Check that the <⚡> icon is lit in the viewfinder.

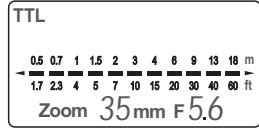

3. Take the picture.
 - Check that the subject is within the effective range displayed on the LCD panel.
 - Right before the shot is taken, a preflash is fired, and then the main flash is fired.

• <TTL> will be displayed on the LCD panel even if the camera is compatible with i-TTL.

Flash Sync Speeds and Apertures Used

	Shutter Speed Setting	Aperture Setting
P	Set automatically (1/60s-1/Xs)	Automatic
S	Set manually (30s-1/Xs)	Automatic
A	Set automatically (30s-1/Xs)	Manual
M	Set manually (buLb,30s-1/Xs)	Manual

• 1/X sec is the camera's maximum flash sync speed.

Using Flash

FEC: Flash Exposure Compensation	-----06
FV Lock: Flash Value Lock	-----06
High-speed Sync	-----07
Bounce Flash	-----07
ZOOM: Setting the Flash Coverage and Using the Wide Panel	-----08
M: Manual Flash	-----09
MULTI: Stroboscopic Flash	-----10
Second-Curtain Sync	-----11
S1/S2 Slave Triggering Mode	-----11
C.Fn: Setting Custom Functions	-----12
Protection Function	-----13

Using i-TTL Autoflash in the Shooting Modes

Just set the camera's shooting mode to <A> (aperture-priority AE), <S> (shutter-priority AE), or <M> (manual) and you can use i-TTL autoflash.

S	<p>Select this mode when you want to set the shutter speed manually. The camera will then automatically set the aperture matching the shutter speed to obtain a standard exposure.</p> <ul style="list-style-type: none"> • If the aperture display blinks, it means that the background exposure will be underexposed or overexposed. Adjust the shutter speed until the aperture display stops blinking.
A	<p>Select this mode when you want to set the aperture manually. The camera will then automatically set the shutter speed matching the aperture to obtain a standard exposure. If the background is dark like a night scene, a slow sync speed will be used to obtain a standard exposure of both the main subject and background.</p> <p>Standard exposure of the main subject is obtained with the flash, while a standard exposure of the background is obtained with a slow shutter speed.</p> <ul style="list-style-type: none"> • Since a slow shutter speed will be used for low-light scenes, using a tripod is recommended. • If the shutter speed displays blinks, it means that the background exposure will be underexposed or overexposed. Adjust the aperture until the shutter speed display stops blinking.
M	<p>Select this mode if you want to set both the shutter speed and aperture manually. Standard exposure of the main subject is obtained with the flash. The exposure of the background is obtained with the shutter speed and aperture combination you set.</p>

FEC: Flash Exposure Compensation

With FEC function, this flash can adjust from -3 to +3 in 1/3rd stops. It is useful in situations where minor adjusting of the TTL system is needed based on the environment.

Setting FEC:

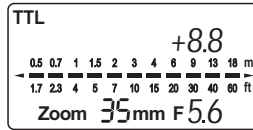
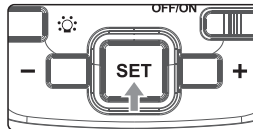

1. Press <SET> button. The flash exposure compensation amount will blink on the LCD panel.
2. Set the flash exposure compensation amount.
 - Press the <-> or <+> button to set the amount.
 - To cancel the flash exposure compensation, set the amount to "+0.0". The amount is not displayed on the LCD panel.

3. Press <SET> button again to confirm the setting. The flash exposure compensation amount stops blinking.

- ▲ The flash exposure compensation amount can only be set in TTL mode.
- If the camera has also set the flash exposure compensation amount, the final flash amount is determined by the common effects of the two amounts.

FV Lock: Flash Value Lock

FV (flash value) lock locks the correct flash exposure setting for any part of the scene. With <TTL> displayed on the LCD panel, you press the camera's <FV> button.

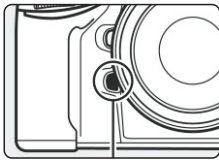

1. Focus the subject.
2. Press the <FV> button.
 - Aim the subject at the center of the viewfinder and press <FV> button.
 - The camera flash will fire a preflash and the required flash output for the subject is retained in memory.

- Each time you press the <FV> button, a preflash will be fired and a new flash exposure setting will be locked. The FV lock icon <FV> will be displayed in the viewfinder.

- ⚠
- If <TTL> is not displayed on the LCD panel, FV lock cannot be set.
 - If the subject is too small, FV lock might not be very effective.
 - <FV> button is on the camera. The <FV> button position may vary based on different Nikon camera models. Please refer to the instruction manuals of your Nikon camera model.

High-speed Sync

With high-speed sync (FP flash), the flash can synchronize with all shutter speeds. This is convenient when you want to use aperture priority for fill-flash portraits.

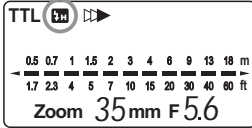

- Select the high-speed sync icon <FP>.
- Set the flash sync speed to 1/320s (Auto FP) or 1/250s (Auto FP) in the Nikon camera menu. Press the shutter button halfway. The

icon <FP> displayed on the flash screen means the high speed sync function is enabled on the flash.

- Turning the camera command dial can set the shutter speed to 1/250s or faster.
- To check if the FP flash function works properly, look through the shutter speed in the viewfinder. If it shows a speed of 1/250s or faster, the FP flash function is on work.

- ⓘ
- If you set a shutter speed as 1/320s (Auto FP) or 1/250s (Auto FP) in the Nikon camera setting, <FP> will be displayed in the flash screen regardless of practical shutter speed.
 - With high-speed sync, the faster the shutter speed, the shorter the effective flash range.
 - To return to normal flash, set the flash sync speed to other options other than Auto FP. Then the icon <FP> will disappear when pressing the shutter halfway.
 - Multi flash mode cannot be set in high-speed sync mode.
 - Over-temperature protection may be activated after 15 consecutive high-speed sync flashes.

Bounce Flash

By pointing the flash head toward a wall or ceiling, the flash will bounce off the surface before illuminating the subject. This can soften shadows behind the subject for a more natural-looking shot. This is called bounce flash.

Set the Bounce Direction

Hold the flash head and turn it to a satisfying angle.

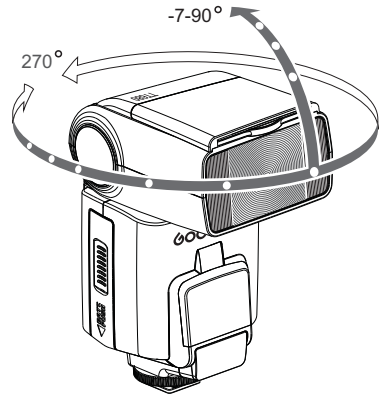

- ⚠
- If the wall or ceiling is too far away, the bounced flash might be too weak and result in underexposure.
 - The wall or ceiling should be a plain, white color for high reflectance. If the bounce surface is not white, a color cast may appear in the picture.

Creating a Catchlight

With the catchlight panel, you can create a catchlight in the subject's eyes to add life to the facial expression.

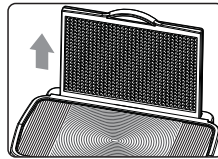

1. Point the flash head upward by 90°.
2. Pull out the wide panel.
- The catchlight panel will come out at the same time.

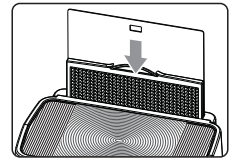

3. Push the wide panel back in.
 - Push in only the wide panel.
 - Follow the same procedures as for bounce flash.

- ⚠
- Point the flash head straight ahead and then upward by 90°. The catchlight will not appear if you swing the flash head left or right.
 - For maximum catchlight effect, stay 1.5m/4.9ft away from the subject.

ZOOM: Setting the Flash Coverage and Using the Wide Panel

The flash coverage can be set to match the lens focal length from 24 mm to 105mm. The flash coverage can be set automatically or manually. Also, with the built-in wide panel, the flash coverage can be expanded for 14mm wide-angle lenses.

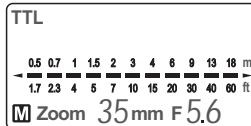

- Press the <ZOOM> button. Press the <ZOOM> button until the Zoom value blinks. Press the <-> or <+> button to change the flash coverage. If <M> is not displayed, the flash coverage will be set automatically.

- If you set the flash coverage manually, make sure it covers the lens focal length so that the picture will not have a dark periphery.
- If you use a commercially-available sync cord to connect the camera to the camera flash' PC terminal, set the flash zoom manually.

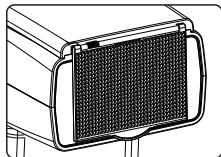

Using the Wide Panel
Pull out the wide panel and place it over the flash head as shown. The flash coverage will then be extended to 14 mm.

- The catchlight panel will come out at the same time. Push the catchlight panel back in.
- The <ZOOM> button will not work.

- ▲ If you use bounce flash with the wide panel in place, the subject will be illuminated by both the bounce flash and direct flash, which will look unnatural.
- Pull out the wide panel gently. Using excessive force may detach the wide panel.

M: Manual Flash

The flash output is adjustable from 1/1 full power to 1/128th power in 1/3rd step increments.

Use a hand-held flash meter to determine the required flash output to obtain a correct flash exposure.

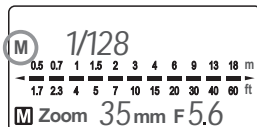

1. Press the <MODE> button so that the <M> is displayed.

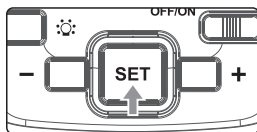

2. Set the flash output.
 - Press the <SET> button.
 - The flash output blinks.
 - Press the <-> button to set a lower value. Or press the <+> button to set a higher value.
 - Press the <SET> button again to lock the settings.
 - Press the shutter button halfway to see the effective flash range displayed.

Flash Output

When you change the flash output during shooting, the following table will make it easier to see how the stop changes such as 1/2-0.3→1/2+0.3 when you increase or decrease the flash output. For example, when you decrease the flash output to 1/2, 1/2-0.3, or 1/2-0.7, and then increase the flash output to more than 1/2, 1/2+0.3, 1/2+0.7, and 1/1 will be displayed.

Figures displayed when reducing flash output level→

1/1	1/1-0.3	1/1-0.7	1/2	1/2-0.3	1/2-0.7	1/4	...
	1/2+0.7	1/2+0.3		1/4+0.7	1/4+0.3		...

←Figures displayed when increasing flash output level

Multi: Stroboscopic Flash

With stroboscopic flash, a rapid series of flashes is fired. It can be used to capture multiple images of a moving subject in a single photograph.

You can set the firing frequency (number of flashes per sec. expressed as Hz), the number of flashes, and the flash output.

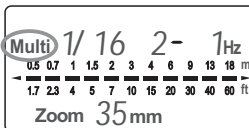

1. Press the <MODE> button so that <Multi> is displayed.

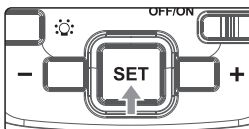

2. Select the item to be set.
 - Press the <SET> button to select the item (blinks).

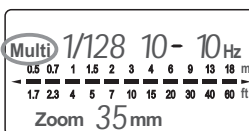

3. Set the desired number.
 - Press the <-> button to set a lower value. Or press the <+> button to set a higher value. Then press the <SET> button. The next item to be set starts blinking.
 - After you set the flash output and press the <SET> button, all the settings will be displayed.

- ▣ Range of flash output:
1/4<->1/8<->1/16<->1/32<->1/64<->1/128

Calculating the Shutter Speed

During stroboscopic flash, the shutter remains open until the firing stops. Use the formula below to calculate the shutter speed and set it with the camera.

Number of flashes / Firing frequency = Shutter speed

For example, if the number of flashes is 10 and the firing frequency is 5 Hz, the shutter speed should be at least 2 sec.

- ▲ To avoid overheating and deteriorating the flash head, do not use stroboscopic flash more than 10 times in succession. After 10 times, allow the camera flash to rest for at least 15 min. If you try to use the stroboscopic flash mode more than 10 times in succession, the firing might stop automatically to protect the flash head. If this happens, allow the camera flash to rest for at least 15 min.

- ▣ Stroboscopic flash is most effective with a highly reflective subject against a dark background.
- Using a tripod, a remote switch, and external power source is recommended.
- A flash output of 1/1 or 1/2 cannot be set for stroboscopic flash.
- Stroboscopic flash can be used with "buLb".

Maximum Stroboscopic Flashes

Hz	Flash Output					
	1/4	1/8	1/16	1/32	1/64	1/128
1 Hz	6	14	30	60	90	90
2 Hz						
3 Hz	5	12	30	60	90	90
4 Hz	4	10	20	50	80	80
5 Hz	4	8	20	40	70	70
6 Hz	3	6	20	32	56	56
7 Hz	3	6	20	28	44	44
8 Hz	3	5	10	24	36	36
9 Hz	3	5	10	22	32	32
10 Hz	2	4	8	20	28	28
20 Hz						
30 Hz						
40 Hz						
50 Hz	2	4	8	12	24	24
60 Hz						
70 Hz						
80 Hz						
90 Hz						

creating multiple lighting effects. It is respectively applicable to manual flash environment. In S1 mode, the flash unit will fire synchronously when the master flash fires, the same effect as that by the use of radio triggers.

S2 Slave Triggering Mode

This mode is also called "Preflash Cancel", similar to S1 mode. In this mode, the flash unit will ignore a single "preflash" from the master flash and will only fire in response to the second, actual flash from the master. Therefore, this flash unit is applicable when using a TTL master flash.

- S1 or S2 mode is not supported in the following cases: when "red-eye reduction" function is started by the master flash (either camera pop-up flash or external on-camera flash); and when the master flash uses the modeling flash function.
- In S1 or S2 mode, the flash output level is only manually adjustable.
- In S1 or S2 mode, TTL flash or Multi flash is not available.
- Setting as S1/S2 slave triggering mode and attaching to the camera, the flash will change to master mode and be set as TTL mode automatically when pressing the shutter button halfway.

▶▶ Second-Curtain Sync

With a slow shutter speed, you can create a light train following the subject. The flash fires right before the shutter closes.

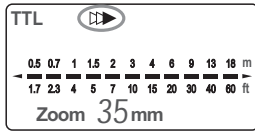

- Set the camera to Rear mode and press the shutter button halfway, then the flash display panel will show the second curtain sync icon <▶▶>.
- When the camera is not set to Rear mode, pressing the shutter button halfway will not light up the icon <▶▶> on the flash display panel.

- Second-curtain sync works well in the camera's "buLb" mode.
- With i-TTL, two flashes will be fired even at slow shutter speeds. The first flash is only the preflash, and not a malfunction.
- Stroboscopic flash cannot be set.

S1/S2 Slave Triggering Mode

This flash unit supports slave triggering mode. To enter S1/S2 mode from the master mode, press < *z > button and hold for seconds, then S1 or S2 will be shown on the LCD display. Setting as S1 mode, press < *z > button will enter S2 mode. Setting as S2 mode, press < *z > button can back to master mode, then S1 or S2 will disappear from the LCD panel.

The flash output setting in slave triggering mode is the same as that in manual mode. After pressing the <SET> button, the flash output blinks. Press the <-> button or <+> button to set a value.

S1 Slave Triggering Mode

In this mode, the flash unit can function as a slave flash for

C.Fn: Setting Custom Functions

The following table lists the available and unavailable custom functions of this flash. The icon "√" indicates the flash custom function is supported but "0" indicates the custom function is not supported.

C.Fn Custom Functions				
Custom Functions No.	Function	Setting No.	Settings & Description	Support or Not
C.Fn-00	Auto power off	0	Enabled	√
		1	Disabled	
C.Fn-01	AF assist	0	Enabled	√
		1	Disabled	
C.Fn-02	Slave auto power off timer	0	60 minutes	√
		1	30 minutes	
C.Fn-03	Slave auto power off cancel	0	Within 8 hours	0
		1	Within 1 hour	
C.Fn-04	Test firing with autoflash	0	1/32	0
		1	Full output	

1. Press < ⚙ > button for 2 seconds or longer until < Fn > is displayed.
2. Select the Custom Function No.
- Press the <-> or <+> button to set the Custom Function No.
3. Change the setting.
 - Press < SET > button and the Setting blinks.
 - Press the <-> or <+> button to set the desired setting. Pressing < SET > button will confirm the settings.
 - After you set the Custom Function and press < MODE > button to exit the Custom Function setting, the camera will be ready to shoot.

Protection Function

1. Over-Temperature Protection

- To avoid overheating and deteriorating the flash head, do not fire more than 20 continuous flashes in fast succession at 1/1 full power. After 20 continuous flashes, allow a rest time of at least 10 minutes.
- If you fire more than 20 continuous flashes and then fire more flashes in short intervals, the inner over-temperature protection function may be activated and make the recycling time about 10 to 15 seconds. If this occurs, allow a rest time of about 10 minutes, and the flash unit will then return to normal.

2. Other Protections

- The system provides real-time protection to secure the device and your safety. The following lists prompts for your reference:

LCD Panel	Meaning
E1	A failure occurs on the recycling system so that the flash cannot fire. Please restart the flash unit. If the problem still exists, please send this product to a maintenance center.
E2	The system gets excessive heat. Please allow a rest time of 10 minutes.
E3	The voltage on two outlets of the flash tube is too high. Please send this product to a maintenance center.

Reference

Specifications-----	13
Troubleshooting Guide-----	15
Compatible Camera Models-----	16

Specifications

• Type

Compatible cameras	Nikon DSLR cameras (i-TTL autofocus)
Guide No.	58/190(at 105mm focal length, ISO 100 in meters/feet)
Flash coverage	24-105mm (14mm with wide panel) •Auto zoom (Flash coverage set automatically to match the lens focal length and image size) •Manual zoom •Swinging/tilting flash head, 0-270°horizontally and -7-90°vertically (Bounce Flash)
Flash duration	1.2ms or shorter

• Exposure Control

Exposure control system	i-TTL autoflash, manual flash
Flash Exposure Compensation (FEC)	Manual. ±3 steps in 1/3 step increments
FV lock:	<FV> button
Sync mode:	High-speed sync (up to 1/8000 seconds), first-curtain sync, and second-curtain sync
Stroboscopic flash:	Provided (1 - 90 Hz)
Optic slave triggering	Provided (S1 & S2)

• Flash Recycling (with size-AA alkaline batteries)

Recycling time	Normal flash: approx. 0.1-5sec.
Flash-ready indicator	Red indicator lights

• AF-Assist Beam

Effective range (approx.)	0.7-6m/2.3-20 feet
---------------------------	--------------------

• Power Source

Internal power	4 size-AA alkaline batteries *Size-AA Ni-MH and lithium batteries also usable
Battery life (approx. flash count)	100-700 flashes (with size-AA alkaline batteries)
Power saving	Power off after certain period (approx. 1.5 min.) of idle operation
External power	Canon battery pack CP-E4 GODOX power pack PB960, PB820, FB2000, and CP-80

• Color Temperature

	5600±200k
--	-----------

• Dimensions

(W x H x D)	83×154×112 mm/ 3.3×6.1×4.4 in.
-------------	--------------------------------

• Weight (approx.)

	395g / 13.9 oz. (camera flash only, excluding batteries)
--	--

Product specifications and external appearance are subject to change without notice.

• Guide No. (at ISO 100, in meters/feet)

Normal Flash (Full output)	15/ 49.2	28/ 91.9	30/ 98.4	39/ 127.9	42/ 137.8	50/ 164	53/ 173.9	58/ 190.3	

Manual Flash

Flash Output	Flash Coverage (mm)								
	14	24	28	35	50	70	80	105	
1/1	15/ 49.2	28/ 91.9	30/ 98.4	39/ 127.9	42/ 137.8	50/ 164	53/ 173.9	58/ 190.3	
1/2	10.6/ 34.8	19.8/ 65	21.2/ 69.6	27.6/ 90.7	29.7/ 97.4	35.4/ 116.1	37.5/ 123	41/ 134.5	
1/4	7.5/ 24.6	14/ 45.9	15/ 49.2	19.5/ 64	21/ 68.9	25/ 82	26.5/ 86.9	29/ 95.1	
1/8	5.3/ 17.4	9.9/ 32.5	10.6/ 34.8	13.7/ 45.2	14.8/ 48.6	17.7/ 58.1	18.7/ 61.4	20.5/ 67.3	
1/16	3.8/ 12.5	7/ 23	7.5/ 24.6	9.7/ 32	10.5/ 34.4	12.5/ 41	13.3/ 43.6	14.5/ 47.6	
1/32	2.7/ 8.9	4.9/ 16.1	5.3/ 17.4	6.9/ 22.7	7.4/ 24.3	8.8/ 28.9	9.4/ 30.8	10.3/ 33.8	
1/64	1.9/ 6.2	3.5/ 11.5	3.8/ 12.5	4.6/ 16	5.3/ 17.4	6.3/ 20.7	6.6/ 21.7	7.3/ 24	
1/128	1.3/ 4.3	2.5/ 8.2	2.7/ 8.9	3.5/ 11.4	3.7/ 12.1	4.4/ 14.4	4.7/ 15.4	5.1/ 16.7	





Troubleshooting Guide

If there is a problem, refer to this Troubleshooting Guide.

The Camera Flash cannot be charged.

- The batteries are installed in the wrong direction.
→ Install the batteries in the correct direction.
- The camera flash's internal batteries are exhausted.
→ If  appears and blinks on the LCD panel, replace the batteries immediately.
→ Install the camera flash's internal batteries even when you use an external power source (through Charging Socket). Otherwise, the camera flash cannot work.



The Camera Flash does not fire.

- The camera flash is not attached securely to the camera.
→ Attach the camera's mounting foot securely to the camera.
- The electrical contacts of the Camera Flash and camera are dirty.
→ Clean the contacts.
-  is not displayed in the view finder of camera.
→ Wait until the flash is fully recycled and the flash ready indicator lights up.
→ If the flash ready indicator lights up, but  is not displayed in the view finder, check whether this flash unit is securely attached to the camera hotshoe.
→ If the flash ready indicator lights up, but  is blinking in the view finder, check whether this flash unit is securely attached to the camera hotshoe. Please power the flash off and reopen it if necessary.
→ If the flash ready indicator does not light up after a long wait, check whether the battery power is enough. If the battery power is low,  will appear and blink on the LCD panel. Please replace the batteries immediately.

The power turns off by itself.

- Setting the flash as master unit, auto power off took effect after 90 sec. of idle operation.
→ Press the shutter button halfway or press the **< TEST >** test flash button to wake up.
- Setting as the slave unit, the flash will enter sleep mode after 60 minutes of idle use (adjustable, 30 minutes by default).
→ Press the **< TEST >** test flash button to wake up.

Auto zoom does not work.

- The flash unit is set to manual zoom mode .
→ Press the **< ZOOM >** button until the  icon disappears.
Then press the **< - >** button to adjust the setting until the  icon disappears.
- The camera flash is not attached securely to the camera.
→ Attach the camera flash's mounting foot to the camera.
- The flash head fails to locate the current position.
→ This occurs because the batteries are exhausted. Replace the batteries immediately.

The flash exposure is underexposed or overexposed.

- There was a highly reflective object (e.g. glass window) in the picture.
→ Use FV lock.
- You used high-speed sync.
→ With high-speed sync, the effective flash range will be shorter.
Make sure the subject is within the effective flash range

displayed.

- You used Manual Flash mode.
→ Set the flash mode to **< TTL >** or modify the flash output.

Photos have dark corners or only parts of the target subject are illuminated.

- The focal length of lens exceeds the flash coverage.
→ Check the flash coverage you set. This flash unit has the flash coverage between 24 and 105mm, which fits medium-format cameras. Pull the wide panel out to extend the flash coverage.

Compatible Camera Models

This flash unit can be used on the following **Nikon DSLR camera models**:

D80	D800	D700	D7100	D7000	D5200	D5100	D5000
D90	D300	D300S	D3200	D3100	D3000	D200	D70S

Note:

1. This table only lists the tested camera models, not all Nikon DSLR cameras. For the compatibility of other camera models, a self-test is recommended.
2. Rights to modify this table are retained.