

Nikon

DIGITAL CAMERA

COOLPIX A10

Reference Manual



En

Introduction	
Parts of the Camera	
Preparing for Shooting	
Using the Camera	
Shooting Features	
Using the Menus	
Connecting the Camera to a TV, Computer, or Printer	
Reference Section	
Technical Notes and Index	

Introduction

Read This First

Thank you for purchasing the Nikon COOLPIX A10 digital camera. Before using the camera, please read the information in “For Your Safety” (📖 vii-x) and familiarize yourself with the information provided in this manual. After reading, please keep this manual handy and refer to it to enhance your enjoyment of your new camera.

Attaching the Camera Strap

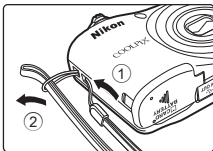

About This Manual





If you want to start using the camera right away, see “Preparing for Shooting” (📖 6) and “Using the Camera” (📖 13).

To learn about the parts of the camera and information that is displayed in the monitor, see “Parts of the Camera” (📖 1).

Other Information

- Symbols and Conventions

To make it easier to find the information you need, the following symbols and conventions are used in this manual:

Icon	Description
	This icon indicates cautions and information that should be read before using the camera.
	This icon indicates notes and information that should be read before using the camera.
	These icons indicate other pages containing relevant information;  : "Reference Section",  : "Technical Notes and Index."

- SD, SDHC, and SDXC memory cards are referred to as "memory cards" in this manual.
- The setting at the time of purchase is referred to as the "default setting."
- The names of menu items displayed in the camera monitor, and the names of buttons or messages displayed on a computer monitor appear in bold.
- In this manual, images are sometimes omitted from monitor display samples so that monitor indicators can be more clearly shown.
- Illustrations and monitor content shown in this manual may differ from the actual product.

Information and Precautions

Life-Long Learning

As part of Nikon's "Life-Long Learning" commitment to ongoing product support and education, continually updated information is available online at the following sites:

- For users in the U.S.A.: <http://www.nikonusa.com/>
- For users in Europe: <http://www.europe-nikon.com/support/>
- For users in Asia, Oceania, the Middle East, and Africa: <http://www.nikon-asia.com/>

Visit these sites to keep up-to-date with the latest product information, tips, answers to frequently asked questions (FAQs), and general advice on digital imaging and photography. Additional information may be available from the Nikon representative in your area. Visit the site below for contact information:

<http://imaging.nikon.com/>

Use Only Nikon Brand Electronic Accessories

Nikon COOLPIX cameras are designed to the highest standards and include complex electronic circuitry. Only Nikon brand electronic accessories (including battery chargers, batteries, AC adapters, and cables) certified by Nikon specifically for use with this Nikon digital camera are engineered and proven to operate within the operational and safety requirements of this electronic circuitry.

THE USE OF NON-NIKON ELECTRONIC ACCESSORIES COULD DAMAGE THE CAMERA AND MAY VOID YOUR NIKON WARRANTY.

For more information about Nikon brand accessories, contact a local authorized Nikon dealer.

Before Taking Important Pictures

Before taking pictures on important occasions (such as at weddings or before taking the camera on a trip), take a test shot to ensure that the camera is functioning normally. Nikon will not be held liable for damages or lost profits that may result from product malfunction.

About the Manuals

- No part of the manuals included with this product may be reproduced, transmitted, transcribed, stored in a retrieval system, or translated into any language in any form, by any means, without Nikon's prior written permission.
- Nikon reserves the right to change the specifications of the hardware and software described in these manuals at any time and without prior notice.
- Nikon will not be held liable for any damages resulting from the use of this product.
- While every effort was made to ensure that the information in these manuals is accurate and complete, we would appreciate it were you to bring any errors or omissions to the attention of the Nikon representative in your area (address provided separately).

Notice Concerning Prohibition of Copying or Reproduction

Note that simply being in possession of material that was digitally copied or reproduced by means of a scanner, digital camera or other device may be punishable by law.

• Items prohibited by law from being copied or reproduced

Do not copy or reproduce paper money, coins, securities, government bonds or local government bonds, even if such copies or reproductions are stamped "Sample." The copying or reproduction of paper money, coins, or securities which are circulated in a foreign country is prohibited. Unless the prior permission of the government was obtained, the copying or reproduction of unused postage stamps or post cards issued by the government is prohibited.

The copying or reproduction of stamps issued by the government and of certified documents stipulated by law is prohibited.

• Cautions on certain copies and reproductions

The government has issued cautions on copies or reproductions of securities issued by private companies (shares, bills, checks, gift certificates, etc.), commuter passes, or coupon tickets, except when a minimum of necessary copies are to be provided for business use by a company. Also, do not copy or reproduce passports issued by the government, licenses issued by public agencies and private groups, ID cards and tickets, such as passes and meal coupons.

• Comply with copyright notices

The copying or reproduction of copyrighted creative works such as books, music, paintings, woodcut prints, maps, drawings, movies, and photographs is governed by national and international copyright laws. Do not use this product for the purpose of making illegal copies or to infringe copyright laws.

Disposing of Data Storage Devices

Please note that deleting images or formatting data storage devices such as memory cards or built-in camera memory does not completely erase the original image data. Deleted files can sometimes be recovered from discarded storage devices using commercially available software, potentially resulting in the malicious use of personal image data. Ensuring the privacy of such data is the user's responsibility.

Before discarding a data storage device or transferring ownership to another person, erase all data using commercial deletion software, or format the device and then completely refill it with images containing no private information (for example, pictures of empty sky). Care should be taken to avoid injury or damage to property when physically destroying data storage devices.

For Your Safety

To prevent damage to your Nikon product or injury to yourself or to others, read the following safety precautions in their entirety before using this equipment. Keep these safety instructions where all those who use the product will read them.



This icon marks warnings, information that should be read before using this Nikon product, to prevent possible injury.

WARNINGS

Turn off in the event of malfunction

Should you notice smoke or an unusual smell coming from the camera or AC adapter, unplug the AC adapter and remove the batteries immediately, taking care to avoid burns. Continued operation could result in injury. After removing or disconnecting the power source, take the equipment to a Nikon-authorized service representative for inspection.

Do not disassemble

Touching the internal parts of the camera or AC adapter could result in injury. Repairs should be performed only by qualified technicians. Should

the camera or AC adapter break open as the result of a fall or other accident, take the product to a Nikon-authorized service representative for inspection, after unplugging the product and/or removing the batteries.

Do not use the camera or AC adapter in the presence of flammable gas

Do not use electronic equipment in the presence of flammable gas, as this could result in explosion or fire.

Handle the camera strap with care

Never place the strap around the neck of an infant or child.

⚠ Keep out of reach of children

Particular care should be taken to prevent infants from putting the batteries or other small parts into their mouths.

⚠ Do not remain in contact with the camera, battery charger, or AC adapter for extended periods while the devices are on or in use

Parts of the devices become hot. Leaving the devices in direct contact with the skin for extended periods may result in low-temperature burns.

⚠ Do not leave the product where it will be exposed to extremely high temperatures, such as in an enclosed automobile or in direct sunlight

Failure to observe this precaution could cause damage or fire.

⚠ Observe caution when handling batteries

Batteries may leak or explode if improperly handled. Observe the following precautions when handling batteries for use in this product:

- Before replacing the batteries, turn the product off. If you are using an AC adapter, be sure it is unplugged.
- Use only the batteries approved for use in this product (📖 7). Do not combine old and new batteries or batteries of different makes or types.
- If Nikon rechargeable Ni-MH batteries EN-MH2 (EN-MH2-B2 or EN-MH2-B4) are purchased separately, charge and use each of them as a set. Do not combine batteries from different pairs.
- The EN-MH2 rechargeable batteries are for use with Nikon digital cameras only, and are compatible with COOLPIX A10.
- Insert batteries in the correct orientation.
- Do not short or disassemble batteries or attempt to remove or break battery insulation or casing.
- Do not expose batteries to flame or to excessive heat.

- Do not immerse in or expose to water.
 - Do not transport or store with metal objects such as necklaces or hairpins.
 - Batteries are prone to leakage when fully discharged. To avoid damage to the product, be sure to remove the batteries when no charge remains.
 - Discontinue use immediately should you notice any change in the batteries, such as discoloration or deformation.
 - If liquid from damaged batteries comes in contact with clothing or skin, rinse immediately with plenty of water.
-  **Observe the following precautions when handling the Battery Chargers (available separately)**
- Keep dry. Failure to observe this precaution could result in fire or electric shock.
 - Dust on or near the metal parts of the plug should be removed with a dry cloth. Continued use could result in fire.
 - Do not handle the power cable or go near the battery charger during lightning storms. Failure to observe this precaution could result in electric shock.
 - Do not damage, modify, forcibly tug or bend the power cable, place it under heavy objects, or expose it to heat or flame. Should the insulation be damaged and the wires become exposed, take it to a Nikon-authorized service representative for inspection. Failure to observe these precautions could result in fire or electric shock.
 - Do not handle the plug or battery charger with wet hands. Failure to observe this precaution could result in electric shock.
 - Do not use with travel converters or adapters designed to convert from one voltage to another or with DC-to-AC inverters. Failure to observe this precaution could damage the product or result in overheating or fire.

 **Use appropriate cables**

When connecting cables to the input and output jacks, use only the cables provided or sold by Nikon for the purpose, to maintain compliance with product regulations.

 **Do not touch the moving parts of the lens**

Failure to observe this precaution could result in injury.

 **Handle moving parts with care**

Be careful that your fingers or other objects are not pinched by the lens cover or other moving parts.

 **Observe caution when using the flash**

Using the flash close to your subject's eyes could cause temporary visual impairment. The flash should be no less than 1 m (3 ft 4 in.) from the subject. Particular care should be observed when photographing infants.

 **Do not operate the flash with the flash window touching a person or object**

Failure to observe this precaution could result in burns or fire.

 **Avoid contact with liquid crystal**

Should the monitor break, care should be taken to avoid injury caused by broken glass and to prevent liquid crystal from the monitor touching the skin or entering the eyes or mouth.

 **Follow the instructions of airline and hospital personnel**

Notices

Notice for Customers in the U.S.A.

Federal Communications Commission (FCC) Radio Frequency Interference Statement

This equipment has been tested and found to comply with the limits for a Class B digital device, pursuant to Part 15 of the FCC rules. These limits are designed to provide reasonable protection against harmful interference in a residential installation. This equipment generates, uses, and can radiate radio frequency energy and, if not installed and used in accordance with the instructions, may cause harmful interference to radio communications. However, there is no guarantee that interference will not occur in a particular installation. If this equipment does cause harmful interference to radio or television reception, which can be determined by turning the equipment off and on, the user is encouraged to try to correct the interference by one or more of the following measures:

- Reorient or relocate the receiving antenna.
- Increase the separation between the equipment and receiver.
- Connect the equipment into an outlet on a circuit different from that to which the receiver is connected.
- Consult the dealer or an experienced radio/television technician for help.

**Nikon**

COOLPIX A10

CAUTIONS

Modifications

The FCC requires the user to be notified that any changes or modifications made to this device that are not expressly approved by Nikon Corporation may void the user's authority to operate the equipment.

Interface Cables

Use the interface cables sold or provided by Nikon for your equipment. Using other interface cables may exceed the limits of Class B Part 15 of the FCC rules.

Notice for Customers in the State of California

WARNING

Handling the cord on this product will expose you to lead, a chemical known to the State of California to cause birth defects or other reproductive harm.

Wash hands after handling.

Nikon Inc.,
1300 Walt Whitman Road Melville,
New York 11747-3064 USA
Tel: 631-547-4200

Notice for Customers in Canada

CAN ICES-3 B / NMB-3 B

Notice for Customers in Europe

This symbol indicates that electrical and electronic equipment is to be collected separately.



The following apply only to users in European countries:

- This product is designated for separate collection at an appropriate collection point. Do not dispose of as household waste.
- Separate collection and recycling helps conserve natural resources and prevent negative consequences for human health and the environment that might result from incorrect disposal.
- For more information, contact the retailer or the local authorities in charge of waste management.

This symbol on the batteries indicates that the batteries are to be collected separately.































The following apply only to users in European countries:













- All batteries, whether marked with this symbol or not, are designated for separate collection at an appropriate collection point. Do not dispose of as household waste.
- For more information, contact the retailer or the local authorities in charge of waste management.

Table of Contents

Introduction	ii	Using the Camera	13
Read This First	ii	Shooting with Scene Auto Selector Mode...	13
Attaching the Camera Strap.....	ii	Using the Zoom	15
About This Manual.....	ii	The Shutter-release Button	15
Information and Precautions	iv	Play Back Images	17
For Your Safety	vii	Delete Images	18
WARNINGS	vii	Using the Flash and Self-timer	20
Notices	xi		
		Shooting Features	21
Parts of the Camera	1	Changing the Shooting Mode	21
The Camera Body	1	Recording and Playing Back Movies	23
The Monitor	3		
Shooting Mode	3	Using the Menus	25
Playback Mode	5		
		Connecting the Camera to a TV, Computer, or Printer	27
Preparing for Shooting	6	Connection Methods.....	27
Insert the Batteries and Memory Card	6	Transferring Images to a Computer (ViewNX-i)	29
Applicable Batteries.....	7	Installing ViewNX-i.....	29
Removing the Batteries or Memory Card ...	8	Transferring Images to a Computer.....	30
Internal Memory and Memory Cards.....	8		
Turn the Camera On and Set the Display Language, Date, and Time	9		

Reference Section	1	Editing Still Images.....	25
(Scene Auto Selector) Mode.....	3	Before Editing Images	25
Scene Mode		Quick Effects:	
(Shooting Suited to Scenes).....	4	Changing Hue or Mood	26
Tips and Notes	5	D-Lighting:	
Special Effects Mode		Enhancing Brightness and Contrast...	27
(Applying Effects When Shooting)	7	Skin Softening:	
Smart Portrait Mode		Softening Skin Tones.....	28
(Capturing Images of Smiling Faces)	8	Small Picture:	
(Auto) Mode	10	Reducing the Size of an Image	29
Functions That Can Be Set Using the Multi		Crop: Creating a Cropped Copy.....	30
Selector.....	11	Connecting the Camera to a TV	
Using the Flash.....	11	(Viewing Images on a TV).....	31
Using the Self-timer.....	14	Connecting the Camera to a Printer	
Using Macro Mode.....	15	(Direct Print).....	32
Adjusting Brightness		Connecting the Camera to a Printer...	32
(Exposure Compensation).....	16	Printing Individual Images.....	33
Default Settings.....	17	Printing Multiple Images	35
Functions That Cannot Be Used		Recording Movies	37
Simultaneously.....	19	Playing Back Movies.....	39
Focusing.....	20	Options Available in the Shooting Menus...	41
Using Face Detection.....	20	The Shooting Menu	
Using Skin Softening.....	21	(for (Auto) Mode).....	42
Subjects Not Suitable for Autofocus...	21	Image Mode Settings	
Focus Lock.....	22	(Image Size and Quality)	42
Playback Zoom	23	White Balance (Adjusting Hue).....	44
Thumbnail Playback, Calendar Display ...	24	Continuous Shooting	46
		ISO Sensitivity.....	47







The Smart Portrait Menu		48
Skin Softening		48
Smile Timer		48
Blink Proof.....		49
The Playback Menu		50
Slide Show		50
Protect.....		51
Rotate Image.....		53
Copy (Copy Between Internal Memory and Memory Card)		54
The Movie Menu		55
Movie Options.....		55
Autofocus Mode		56
The Setup Menu		57
Time Zone and Date		57
Monitor Settings		60
Date Stamp		62
Electronic VR		63
Sound Settings		64
Auto Off.....		64
Format Memory/Format Card.....		65
Language		65
Video Mode		65
Reset All.....		66
Battery Type.....		66
Firmware Version.....		67
Error Messages		68
File Names		71
Optional Accessories		72

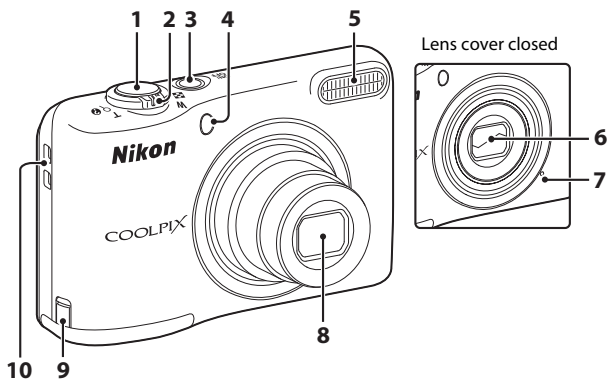

Technical Notes and Index		1
Caring for the Product		2
The Camera.....		2
Batteries.....		4
Memory Cards		6
Cleaning and Storage		7
Cleaning		7
Storage		7
Troubleshooting		8
Specifications		15
Applicable Memory Cards		19
Index		21

Parts of the Camera

The Camera Body



1	Shutter-release button.....	14
2	Zoom control.....	15
	W : wide-angle.....	15
	T : telephoto.....	15
	 : thumbnail playback.....	17,  24
	 : playback zoom.....	17,  23
	 : help.....	 4
3	Power switch/power-on lamp.....	9
4	Self-timer lamp.....	 14

5	Flash.....	20,  11
6	Lens cover.....	
7	Microphone.....	 37
8	Lens.....	
9	Power connector cover (for connection with optional AC adapter).....	 72
10	Eyelet for camera strap.....	ii

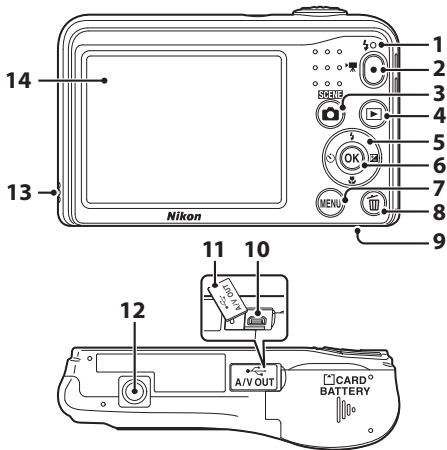

1	Flash lamp.....		13
2	(movie-record) button.....	23,	37
3	(shooting mode) button	21, 3, 4, 7, 8,	10
4	(playback) button.....		17
5	Multi selector.....		25
6	(apply selection) button.....		25
7	MENU (menu) button.....		25
8	(delete) button.....		18
9	Battery-chamber/ memory card slot cover.....		6
10	USB/audio/video output connector.....		27
11	Connector cover.....		27
12	Tripod socket.....		17
13	Speaker.....		39
14	Monitor.....		3









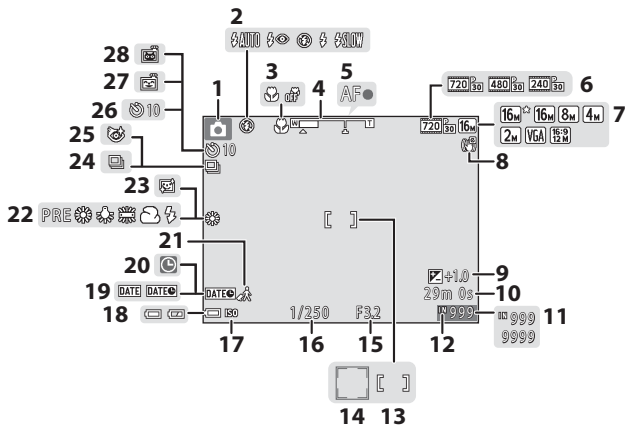













The Monitor

The information that is displayed changes depending on the camera's settings and state of use.

By default, information is displayed when the camera is first turned on and when you operate the camera, and turns off after a few seconds (when **Photo info** is set to **Auto info** in **Monitor settings** (📖 25, 🔄60) in the setup menu).

Shooting Mode



1	Shooting mode.....	21
2	Flash mode.....	20,  11
3	Macro mode.....	20,  15
4	Zoom indicator.....	15,  15
5	Focus indicator.....	14
6	Movie options.....	 55
7	Image mode.....	 42
8	Electronic VR icon.....	 63
9	Exposure compensation value...20,  16	
10	Movie recording time remaining	23,  37
11	Number of exposures remaining (still images).....	11
12	Internal memory indicator.....	11
13	Focus area.....	14
14	Focus area (face detection, pet detection).....	14,  6,  8
15	Aperture value.....	15
16	Shutter speed.....	15
17	ISO sensitivity.....	 47
18	Battery level indicator.....	11
19	Date stamp.....	 62
20	“Date not set” indicator.....	9,  57
21	Travel destination icon.....	 57
22	White balance mode.....	 44
23	Skin softening.....	 48
24	Continuous shooting mode	 6,  46
25	Blink proof icon.....	 49
26	Self-timer indicator.....	20,  14
27	Smile timer.....	 48
28	Pet portrait auto release.....	 6

Playback Mode

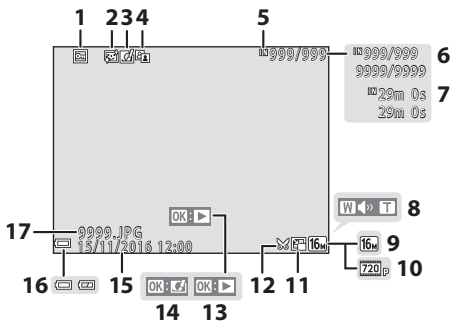

1	Protect icon.....		51
2	Skin softening icon.....		28
3	Quick effects icon.....		26
4	D-Lighting icon.....		27
5	Internal memory indicator.....		8
6	Current image number/ total number of images		
7	Movie length		
8	Volume indicator.....		39
9	Image mode.....		42

10	Movie options.....	23,	55
11	Small picture icon.....		29
12	Crop icon.....	23,	30
13	Movie playback guide.....	23,	39
14	Quick effects guide.....	17,	26
15	Shooting date and time.....		9
16	Battery level indicator.....		11
17	File number and type.....		71

Preparing for Shooting

Insert the Batteries and Memory Card

- 1** Open the battery-chamber/memory card slot cover.

- Hold the camera upside down to prevent the batteries from falling out.

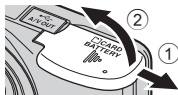

- 2** Insert the batteries and memory card.

- Confirm that the positive (+) and negative (-) battery terminals are oriented correctly and insert the batteries.
- Confirm the correct orientation and slide the memory card in until it clicks into place.

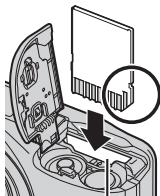
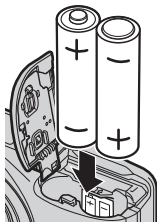

Memory card slot

- ✓ Be Careful to Insert the Memory Card in Correct Direction**

Inserting the memory card upside down or backwards could damage the camera and the memory card.

- 3** Close the battery-chamber/memory card slot cover.

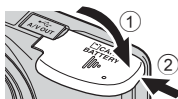

Applicable Batteries

- Two LR6/L40 (AA-size) alkaline batteries (included batteries)*
 - Two FR6/L91 (AA-size) lithium batteries
 - Two EN-MH2 rechargeable Ni-MH (nickel metal hydride) batteries
- * Performance of alkaline batteries may vary greatly depending on the brand. Although the batteries are described as being "included" in this manual, the batteries may not be included depending on the country or region in which the camera was purchased.

✓ Notes About the Batteries

- Do not combine old and new batteries or batteries of different makes or types.
- Batteries with the following defects cannot be used:

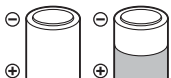

Batteries with peeling



Batteries with insulation that does not cover the area around the negative terminal

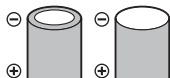

Batteries with a flat negative terminal

✓ Formatting Memory Cards

The first time you insert a memory card that has been used in another device into this camera, make sure to format it with this camera. Insert the card into the camera, press the **MENU** button, and select **Format card** (📖 25, 📷 65) in the setup menu.

Removing the Batteries or Memory Card

Turn the camera off and make sure that the power-on lamp and the monitor have turned off, and then open the battery-chamber/memory card slot cover.

Gently push the memory card into the camera (①) to partially eject the card (②).

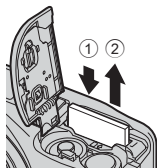

High Temperature Caution

The camera, batteries, and memory card may be hot immediately after using the camera.

Internal Memory and Memory Cards

Camera data, including images and movies, can be saved either in the camera's internal memory or on a memory card. To use the camera's internal memory, first remove the memory card.

Turn the Camera On and Set the Display Language, Date, and Time

When the camera is turned on for the first time, the language-selection screen and the date and time setting screen for the camera clock are displayed.

- If you exit without setting the date and time,  will flash when the shooting screen is displayed.

1 Press the power switch to turn on the camera.

- The monitor turns on when the camera is turned on.
- To turn the camera off, press the power switch again.

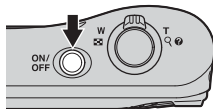

2 Use the multi selector ▲▼ to select the desired language and press the button.

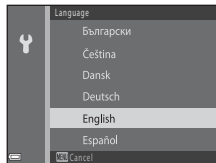

3 Use ▲▼ to select **Yes** and press the button.

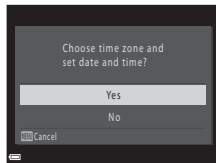

4 Use ◀▶ to select your home time zone and press the **OK** button.

- Press ▲ to turn on daylight saving time (☀ is displayed above the map).
Press ▼ to turn it off.

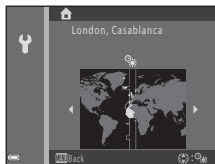

5 Use ▲▼ to select the date format and press the **OK** button.

6 Set the date and time, and press the **OK** button.

- Use ◀▶ to select a field and then use ▲▼ to set the date and time.
- Select the minute field and press the **OK** button to confirm the setting.

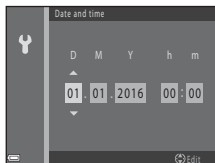

7 When the confirmation screen is displayed, use ▲▼ to select **Yes** and press the **OK** button.

8 Press the (shooting mode) button.

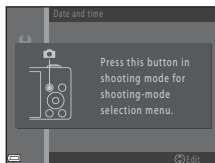

9 Use ▲▼ to select **Scene auto selector** and press the **OK** button.

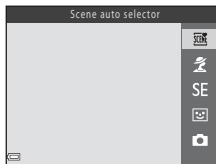

- The camera enters the shooting mode and you can take images in Scene auto selector mode.
- While shooting, you can check the battery level indicator and the number of exposures remaining.

- Battery level indicator



The battery level is high.



The battery level is low. Prepare to replace the batteries.

- Number of exposures remaining

The number of images that can be taken

is displayed. **11** is displayed when no memory card is inserted in the camera, and images are saved in the internal memory.

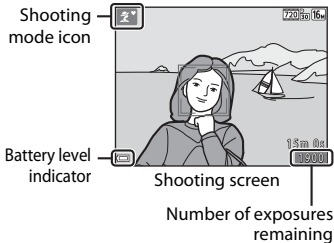

The Auto Off Function

- If you do not operate the camera for about 30 seconds, the monitor turns off, the camera enters standby mode, and the power-on lamp flashes. The camera turns off after about three minutes in standby mode.
- The amount of time until the camera enters standby mode can be changed using the **Auto off** setting (📖 25, 🎛️64) in the setup menu.
- While the camera is in standby mode, the monitor turns back on if you perform any of the following operations:
 - Press the power switch, shutter-release button, 📷 (shooting mode) button, ▶️ (playback) button, or ⏏️ (movie-record) button

Changing the Language Setting and the Date and Time Setting

- You can change these settings using the **Language** and **Time zone and date** settings in the 🗨️ setup menu (📖 25).
- You can enable or disable daylight saving time in the 🗨️ setup menu by selecting **Time zone and date** followed by **Time zone**. Press the multi selector ▶️ and then ▲ to enable daylight saving time and move the clock forward one hour, or ▼ to disable daylight saving time and move the clock back one hour.

The Clock Battery

- The camera's clock is powered by a built-in backup battery. The backup battery is charged when the main batteries are inserted into the camera or when the camera is connected to an optional AC adapter, and it can run the clock for several days after about ten hours of charging.
- If the camera's backup battery becomes exhausted, the date and time setting screen is displayed when the camera is turned on. Set the date and time again. See step 3 (📖 9) of "Turn the Camera On and Set the Display Language, Date, and Time" for more information.

Using the Camera

Shooting with Scene Auto Selector Mode

1 Hold the camera steady.

- Keep fingers and other objects away from the lens, flash, microphone, and speaker.
- When taking pictures in the “tall” (portrait) orientation, make sure the flash is above the lens.

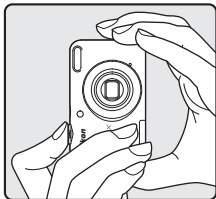
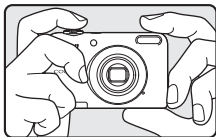

2 Frame the picture.

- Move the zoom control to change the zoom position (📖 15).
- When the camera automatically determines the scene mode, the shooting mode icon changes.

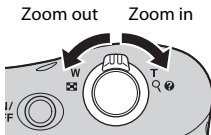

3 Press the shutter-release button halfway (📖 15).

- When the subject is in focus, the focus area glows green.
- Multiple focus areas can glow green.
- When you are using digital zoom, the camera focuses on the subject in the center of the frame and the focus area is not displayed. When the camera has focused, the focus indicator (📖 3) glows green.
- If the focus area or focus indicator flashes, the camera is unable to focus. Modify the composition and try pressing the shutter-release button halfway again.

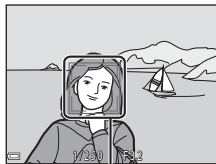
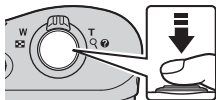

Focus area

4 Without lifting your finger, press the shutter-release button the rest of the way down (📖 15).



Using the Zoom

When you move the zoom control, the zoom lens position changes.

- To zoom in closer to the subject: Move toward **T** (telephoto)
- To zoom out and view a larger area: Move toward **W** (wide-angle)

When you turn the camera on, the zoom moves to the maximum wide-angle position.

- A zoom indicator is displayed at the top of the monitor when the zoom control is moved.
- Digital zoom, which allows you to further magnify the subject up to approximately 4x the maximum optical zoom ratio, can be activated by moving and holding the zoom control toward **T** when the camera is zoomed in to the maximum optical zoom position.

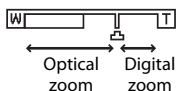
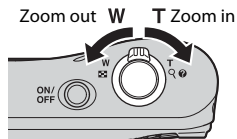

Digital Zoom and Interpolation

While using digital zoom, the image quality decreases due to interpolation when the zoom is increased beyond the  position.

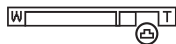

The Shutter-release Button

Press halfway







To set focus and exposure (shutter speed and aperture value), press the shutter-release button lightly (halfway) until you feel a slight resistance. Focus and exposure remain locked while the shutter-release button is pressed halfway.

Press all the way



Press the shutter-release button all the way to release the shutter and take an image. Do not use force when pressing the shutter-release button, as this may result in camera shake and blurred images. Press the button gently.

Notes About Scene Auto Selector Mode



- Depending upon shooting conditions, the camera may not select the desired scene mode. In this case, select another shooting mode (, , , .
- When the digital zoom is in effect, the shooting mode icon changes to .

Notes About Saving Images and Recording Movies

The indicator showing the number of exposures remaining or the indicator showing the maximum movie length flashes while images are being saved or while a movie is being recorded. **Do not open the battery-chamber/memory card slot cover or remove the batteries or memory card** while an indicator is flashing. Doing this could result in loss of data, or in damage to the camera or the memory card.

When Using a Tripod

We recommend using a tripod to stabilize the camera in the following situations.

- When shooting in dim lighting
- When shooting with the flash mode () set to  (off)
- When using the telephoto setting



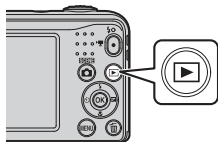

Play Back Images

1 Press the  (playback) button to enter playback mode.

- If you press and hold down the  (playback) button while the camera is turned off, the camera turns on in playback mode.





2 Use the multi selector  to select an image to display.



- To return to shooting mode, press the  button or shutter-release button.
- When :  is displayed in full-frame playback mode, you can press the  button to apply an effect to the image (26).



Full-frame Playback

- Move the zoom control toward **T** () in full-frame playback mode to zoom in on the image (23).



- Move the zoom control toward **W** () in full-frame playback mode to display a list of images called "thumbnails" (24).



Delete Images

- 1 Press the  (delete) button to delete the image currently displayed in the monitor.

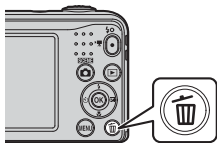

- 2 Use the multi selector   to select **Current image** and press the  button.

- **Current image:** The image currently displayed is deleted.
- **Erase selected images:** Multiple images that you select are deleted (see page 19).
- **All images:** All images are deleted.
- To exit without deleting, press the **MENU** button.

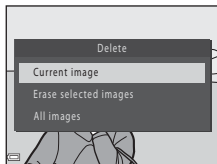

- 3 Select **Yes** and press the  button.

- Deleted images cannot be recovered.

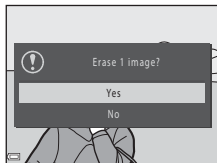

Operating the Erase Selected Images Screen

1 Use the multi selector ◀▶ to select an image to be deleted, and then use ▲ to display 🗑️.

- To undo the selection, press ▼ to remove 🗑️.
- Move the zoom control (□ 1) toward **T** (🔍) to switch to full-frame playback or **W** (🖼️) to switch to thumbnail playback.

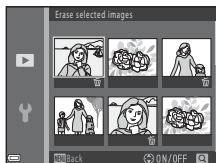

2 Add 🗑️ to all images that you want to delete and then press the **OK** button to confirm the selection.

- A confirmation dialog is displayed. Follow the instructions displayed in the monitor.

Deleting the Last Image Captured While in Shooting Mode

When using shooting mode, press the 🗑️ button to delete the last image that was saved.

Using the Flash and Self-timer

You can use the multi selector to set frequently used functions such as the flash and self-timer.

You can set the following functions using ▲▼◀▶ in the shooting screen.

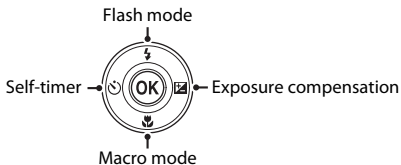

- **Flash mode** (📷11)
You can select the flash mode to match the shooting conditions.
- **Self-timer** (📷14)
If you select **ON**, the camera releases the shutter 10 seconds after you press the shutter-release button.
- **Macro mode** (📷15)
Use macro mode when taking close-up images.
- **Exposure compensation** (📷16)
You can adjust overall image brightness.

The functions that are available vary with the shooting mode.

Shooting Features

Changing the Shooting Mode

The following shooting modes are available.

- **SA** Scene auto selector (0-03)
The camera automatically selects the optimum scene mode when you frame an image, making it even easier to take images using settings that suit the scene.
- **S** Scene mode (0-04)
Camera settings are optimized according to the scene that you select.
- **SE** Special effects (0-07)
Effects can be applied to images during shooting.
- **SM** Smart portrait (0-08)
When the camera detects a smiling face, you can take an image automatically without pressing the shutter-release button (smile timer).
You can also use the skin softening option to smooth the skin tones of human faces.
- **A** Auto mode (0-010)
Used for general shooting.
Settings can be adjusted to suit the shooting conditions and the type of shot you want to capture.

- 1 Press the  (shooting mode) button in the shooting screen.

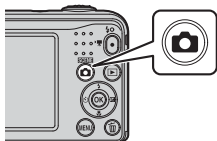

- 2 Use the multi selector ▲▼ to select a shooting mode and press the **OK** button.

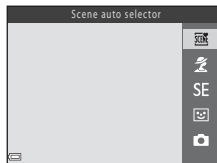

Recording and Playing Back Movies

1 Display the shooting screen.

- Check the remaining amount of movie recording time.



Movie recording time remaining

2 Press the (movie-record) button to start movie recording.

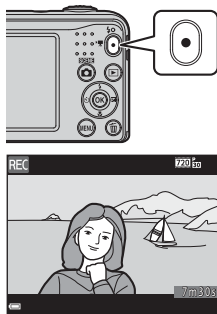

3 Press the (movie-record) button again to stop recording.

4 Select a movie in full-frame playback mode and press the **OK** button.

- Movies are indicated by the movie options icon.
- See “Recording Movies” (📷37) for more information.
- See “Playing Back Movies” (📺39) for more information.

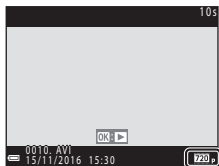

Movie options

Using the Menus

Use the multi selector and **OK** button to navigate the menus.

The following menus are available.

- **Shooting menu** (📷41)
Available by pressing the **MENU** button in the shooting screen.
Allows you to change image size and quality, continuous shooting settings, etc.
- **Playback menu** (▶50)
Available by pressing the **MENU** button when viewing images in full-frame playback mode or thumbnail playback mode. Allows you to edit images, play slide shows, etc.
- **Movie menu** (🎥55)
Available by pressing the **MENU** button in the shooting screen.
Allows you to change movie recording settings.
- **Setup menu** (🔧57)
Allows you to adjust basic camera functions such as date and time, display language, etc.

1 Press the **MENU** (menu) button.

- The menu is displayed.



2 Press the multi selector ◀.

- The current menu icon is displayed in yellow.

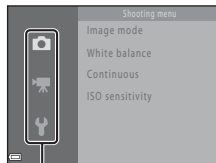

Menu icons

3 Use ▲▼ to select the desired menu icon.

- The menu is changed.

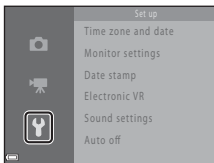

4 Press the OK button.

- The menu options become selectable.

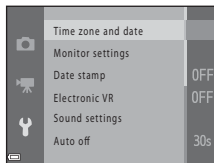

5 Use ▲▼ to select a menu option, and then press the OK button.

- The settings for the option you selected are displayed.

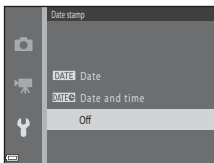

6 Use ▲▼ to select the setting, and then press the OK button.

- The setting you selected is applied.
- When you are finished using the menu, press the MENU button.

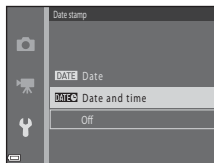

- Certain menu options cannot be set depending on the current shooting mode or the state of the camera.
- When a menu is displayed, you can switch to shooting mode by pressing the shutter-release button, (shooting mode) button, or (movie-record) button.

Viewing images on a TV 31

Images and movies captured with the camera can be viewed on a TV.
Connection method: Connect the video and audio plugs of the Audio Video Cable EG-CP14 to the TV's input jacks.

Transferring images to a computer (ViewNX-i) 29

You can transfer images and movies to a computer for viewing and editing.
Connection method: Connect the camera to the computer's USB port with the USB Cable UC-E16.

- Before connecting to a computer, install ViewNX-i on the computer ( 29).

Printing images without using a computer 32

If you connect the camera to a PictBridge-compatible printer, you can print images without using a computer.
Connection method: Connect the camera directly to the printer's USB port with the USB Cable UC-E16.

Transferring Images to a Computer (ViewNX-i)

Installing ViewNX-i

ViewNX-i is free software that enables you to transfer images and movies to your computer for viewing and editing.

To install ViewNX-i, download the latest version of the ViewNX-i installer from the following website and follow the on-screen instructions to complete installation.

ViewNX-i: <http://downloadcenter.nikonimglib.com>

For system requirements and other information, see the Nikon website for your region.

Transferring Images to a Computer

1 Prepare a memory card that contains images.

You can use any of the methods below to transfer images from the memory card to a computer.

- **SD memory card slot/card reader:** Insert the memory card into the card slot of your computer or the card reader (commercially available) that is connected to the computer.
- **Direct USB connection:** Turn the camera off and ensure that the memory card is inserted in the camera. Connect the camera to the computer using the USB cable. Turn the camera on.

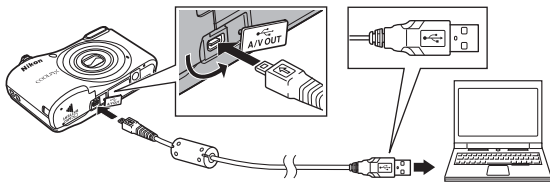

Transferring Images Saved in the Internal Memory to the Computer

Perform one of the methods listed below.

- Using **Copy** (📖 25, 🛠️ 54) in the playback menu, copy the images saved in the internal memory to the memory card, and then transfer the images saved in the memory card to the computer.
- Connect the camera to the computer without inserting a memory card into the camera.

If a message is displayed prompting you to choose a program, select Nikon Transfer 2.

- **When using Windows 7**

If the dialog shown on the right is displayed, follow the steps below to select Nikon Transfer 2.

- 1 Under **Import pictures and videos**, click **Change program**. A program selection dialog will be displayed; select **Import File using Nikon Transfer 2** and click **OK**.
- 2 Double-click **Import File**.



- **When using Windows 10 or Windows 8.1**

If the dialog shown on the right is displayed, click the dialog and then click **Import File/Nikon Transfer 2**.

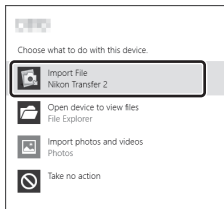

- **When using Mac OS X**

If Nikon Transfer 2 does not automatically start, launch the **Image Capture** application that comes bundled with Mac while the camera and your computer are connected, and select Nikon Transfer 2 as the default application to open when the camera is connected to your computer.

If the memory card contains a large number of images, it may take a while for Nikon Transfer 2 to start. Wait until Nikon Transfer 2 starts.

✓ Notes About Connecting the USB Cable

Operation is not guaranteed if the camera is connected to the computer via a USB hub.

✎ Using ViewNX-i

Consult online help for more information.

2 After Nikon Transfer 2 starts, click **Start Transfer**.



- Image transfer begins. When image transfer is complete, ViewNX-i starts and the transferred images are displayed.

3 Terminate the connection.











- If you are using a card reader or card slot, choose the appropriate option in the computer operating system to eject the removable disk corresponding to the memory card and then remove the memory card from the card reader or card slot.
- If the camera is connected to the computer, turn the camera off and disconnect the USB cable.







Reference Section

The Reference Section provides detailed information and hints about using the camera.



Shooting

 (Scene Auto Selector) Mode	 3
Scene Mode (Shooting Suited to Scenes)	 4
Special Effects Mode (Applying Effects When Shooting).....	 7
Smart Portrait Mode (Capturing Images of Smiling Faces)	 8
 (Auto) Mode.....	 10
Functions That Can Be Set Using the Multi Selector	 11
Functions That Cannot Be Used Simultaneously.....	 19
Focusing	 20







Playback

Playback Zoom.....	 23
Thumbnail Playback, Calendar Display	 24
Editing Still Images	 25
Connecting the Camera to a TV (Viewing Images on a TV).....	 31
Connecting the Camera to a Printer (Direct Print)	 32



Movies

Recording Movies.....	 37
Playing Back Movies	 39

Menu



Options Available in the Shooting Menus	 41
The Shooting Menu (for  (Auto) Mode).....	 42
The Smart Portrait Menu.....	 48
The Playback Menu.....	 50
The Movie Menu	 55
The Setup Menu.....	 57

Additional Information







Error Messages	 68
File Names.....	 71
Optional Accessories.....	 72

(Scene Auto Selector) Mode





The camera automatically recognizes the shooting scene when you frame a picture, making it easier to take pictures using settings that suit the scene.

Enter shooting mode →  (shooting mode) button →  (scene auto selector) mode →  button

When the camera automatically recognizes the shooting scene, the shooting mode icon displayed on the shooting screen changes accordingly.







	Portrait
	Landscape
	Night portrait
	Night landscape
	Close-up
	Backlighting
	Other scenes

Functions Available in (Scene Auto Selector) Mode

- Flash mode (11)
- Self-timer (14)
- Exposure compensation (16)
- Scene auto selector mode menu (41)

Scene Mode (Shooting Suited to Scenes)

When a scene is selected, camera settings are automatically optimized for the selected scene.

Enter shooting mode →  (shooting mode) button →  (second icon from the top*)
→     → select a scene →  button

* The icon of the last scene selected is displayed.



 Portrait (default setting)	 Landscape ²	 Sports ¹ ()5	 Night portrait ³ ()5
 Party/indoor ¹ ()5	 Beach ¹	 Snow ¹	 Sunset ^{1,3}
 Dusk/dawn ^{2,3}	 Night landscape ^{2,3}	 Close-up ¹ ()5	 Food ¹ ()5
 Fireworks show ^{2,3} ()6	 Backlighting ¹ ()6	 Pet portrait ()6	

¹ The camera focuses on the area in the center of the frame.

² The camera focuses at infinity.

³ Use of a tripod is recommended, because the shutter speed is slow.

To View a Description (Help Display) of Each Scene

Select a scene and move the zoom control ( 1) toward **T** () to view a description of that scene. To return to the original screen, move the zoom control toward **T** () again.

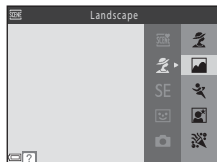

Tips and Notes

Sports

- While the shutter-release button is held all the way down, the camera shoots up to about 6 images continuously at a rate of about 1.2 fps (when **Image mode** is set to **16M 4608x3456**).
- The frame rate for continuous shooting may vary depending upon the current image mode setting, the memory card used, or shooting condition.
- Focus, exposure, and hue are fixed at the values determined with the first image in each series.

Night portrait

- The flash always fires.



Party/indoor

- To avoid the effects of camera shake, hold the camera steady.

Close-up

- Macro mode (15) is enabled and the camera automatically zooms to the closest position at which it can focus.

Food

- Macro mode (15) is enabled and the camera automatically zooms to the closest position at which it can focus.
- You can adjust hue by using the multi selector . The hue setting is saved in the camera's memory even after the camera is turned off.







Fireworks show

- The shutter speed is fixed at about four seconds.



Backlighting

- The flash always fires.

Pet portrait

- When you point the camera at a dog or cat, the camera detects the pet's face and focuses on it. By default, the shutter is automatically released when the camera detects a dog or cat face (pet portrait auto release).
- From the screen displayed after  **Pet portrait** is selected, select  **Single** or  **Continuous**.
 -  **Single**: Whenever the camera detects a dog or cat face, it captures one image.
 -  **Continuous**: Whenever the camera detects a dog or cat face, it captures three images continuously.

Pet Portrait Auto Release

- Press the multi selector  to change the **Pet portrait auto release** settings.
 - : The shutter is automatically released when the camera detects a dog or cat face.
 - **OFF**: The camera does not release the shutter automatically, even if a dog or cat face is detected. Press the shutter-release button.
- **Pet portrait auto release** is set to **OFF** after five bursts have been taken.
- Shooting is also possible by pressing the shutter-release button, regardless of the **Pet portrait auto release** setting. When  **Continuous** is selected, you can take images continuously while holding down the shutter-release button all the way.



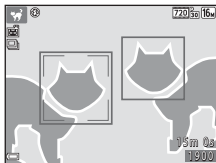

Focus Area

- When the camera detects a face, the face is displayed inside a yellow border. When the camera acquires focus on a face displayed inside a double border (focus area), the double border turns green. If no faces are detected, the camera focuses on the subject in the center of the frame.
- In some shooting conditions, the pet face may not be detected and other subjects may be displayed inside a border.





Special Effects Mode (Applying Effects When Shooting)





Effects can be applied to images during shooting.

Enter shooting mode →  (shooting mode) button → SE (third icon from the top*) →    → select an effect →  button

* The icon of the last effect selected is displayed.

Type	Description
SE Nostalgic sepia (default setting)	Adds a sepia tone and reduces the contrast to simulate the qualities of an old photograph.
 High-contrast monochrome	Changes the image to black and white and gives it sharp contrast.
 Selective color*	Creates a black and white image in which only the specified color remains.
POP Pop*	Increases the color saturation of the entire image to create a bright look.
CO Cyanotype	Changes the color of the entire image into blue monotone.
 Mirror*	Creates a bilaterally symmetric image whose right half is an inverted mirror image of the left half.

* The effect is not applied to movies.

- The camera focuses on the area in the center of the frame.
- When **Selective color** is selected, use the multi selector   to select the desired color, and press the  button to apply the color. To change the color selection, press the  button again.



Smart Portrait Mode (Capturing Images of Smiling Faces)

When the camera detects a smiling face, you can take an image automatically without pressing the shutter-release button (smile timer (📷48)). You can use the skin softening option to smooth the skin tones of human faces.

Enter shooting mode → 📷 (shooting mode) button → 😊 Smart portrait mode → ⓧ button

1 Frame the picture.

- Point the camera at a human face.

2 Without pressing the shutter-release button, wait for the subject to smile.

- If the camera detects that the face framed by the double border is smiling, the shutter is automatically released.
- Whenever the camera detects a smiling face, it automatically releases the shutter.

3 End automatic shooting.

- Perform one of the operations listed below to end shooting.
 - Set **Smile timer to Off**.
 - Press the 📷 button and select a different shooting mode.

✔ Notes About Smart Portrait Mode

Under some shooting conditions, the camera may be unable to detect faces or detect smiles (📷20). The shutter-release button can also be used for shooting.

📌 When the Self-timer Lamp Flashes

When using smile timer, the self-timer lamp flashes when the camera detects a face and flashes quickly immediately after the shutter is released.

Functions Available in Smart Portrait Mode

- Flash mode (👁️11)
- Self-timer (👁️14)
- Exposure compensation (👁️16)
- Smart portrait menu (👁️41)





(Auto) Mode

Used for general shooting. Settings can be adjusted to suit the shooting conditions and the type of shot you want to capture.

Enter shooting mode →  (shooting mode) button →  (auto) mode →  button

- The camera focuses on the area in the center of the frame.

Functions Available in (Auto) Mode

- Flash mode (11)
- Self-timer (14)
- Macro mode (15)
- Exposure compensation (16)
- Shooting menu (41)

Functions That Can Be Set Using the Multi Selector

The functions that are available vary with the shooting mode (🔑17).

Using the Flash

When using 📷 (auto) mode and other shooting modes, you can select the flash mode to match the shooting conditions.

1 Press the multi selector ▲ (⚡).



2 Select the desired flash mode (🔑12) and press the Ⓞ button.

- If a setting is not applied by pressing the Ⓞ button within a few seconds, the selection will be canceled.

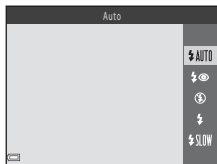

Available Flash Modes

AUTO Auto

The flash fires when necessary, such as in dim lighting.

- The flash mode icon on the shooting screen is displayed only immediately after the setting is made.

Auto with red-eye reduction

Reduce red-eye in portraits caused by the flash (13).

Off

The flash does not fire.

- We recommend using a tripod to stabilize the camera when shooting in dark surroundings.

Fill flash

The flash fires whenever an image is taken. Use to “fill-in” (illuminate) shadows and backlit subjects.

SLOW

Suited to evening and night portraits that include background scenery. The flash fires when necessary to illuminate the main subject; slow shutter speeds are used to capture background at night or under dim lighting.

The Flash Lamp



The status of the flash can be confirmed by pressing the shutter-release button halfway.

- On: The flash fires when you press the shutter-release button all the way down.
- Flashing: The flash is charging. The camera cannot shoot images.
- Off: The flash does not fire when an image is taken.

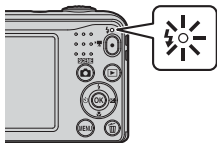
If the battery level is low, the monitor turns off while the flash is charging.



The Flash Mode Setting

- The setting may not be available with some shooting modes ( 17).
- The setting applied in  (auto) mode is saved in the camera's memory even after the camera is turned off.

Red-eye Reduction

Pre-flashes are fired repeatedly at low intensity before the main flash, reducing the red-eye effect. Additionally, if the camera detects red eye while saving an image, the affected area is processed to reduce red-eye before the image is saved.

Note the following when shooting:

- Because pre-flashes are fired, there is a slight lag between when the shutter-release button is pressed and when the shutter is released.
- More time than usual is required to save images.
- Red-eye reduction may not produce the desired results in all situations.
- In some cases, red-eye reduction may be applied to areas of an image unnecessarily. In these cases, select another flash mode and take the image again.



Using the Self-timer

The camera is equipped with a self-timer that releases the shutter about ten seconds after you press the shutter-release button.

1 Press the multi selector ◀ (⏻).



2 Select **ON** and press the **OK** button.

- If a setting is not applied by pressing the **OK** button within a few seconds, the selection will be canceled.
- When the shooting mode is **Pet portrait** scene mode,  (pet portrait auto release) is displayed (6). The self-timer cannot be used.

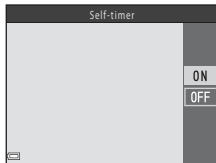

3 Frame the picture and press the shutter-release button halfway.

- Focus and exposure are set.



4 Press the shutter-release button the rest of the way down.

- Countdown starts. The self-timer lamp flashes and then glows steadily about one second before the shutter is released.
- When the shutter is released, the self-timer is set to **OFF**.
- To stop the countdown, press the shutter-release button again.



The Self-timer Setting

The setting may not be available with some shooting modes (17).

Using Macro Mode

Use macro mode when taking close-up images.

- 1 Press the multi selector ▼ (👉).



- 2 Select **ON** and press the **OK** button.

- If a setting is not applied by pressing the **OK** button within a few seconds, the selection will be canceled.

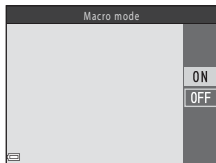

- 3 Move the zoom control to set the zoom ratio to a position where 👉 and the zoom indicator glow green.



- When the zoom ratio is set to a position where 👉 and the zoom indicator glow green, the camera can focus on subjects as close as approximately 30 cm (1 ft) from the lens. When the zoom is at the position where 📷 is displayed, the camera can focus on subjects as close as approximately 10 cm (4 in.) from the lens.

✓ Notes About Using the Flash

The flash may be unable to light the entire subject at distances of less than 50 cm (1 ft 8 in.).

📎 The Macro Mode Setting

- The setting may not be available with some shooting modes (📷17).
- The setting applied in 📷 (auto) mode is saved in the camera's memory even after the camera is turned off.

Adjusting Brightness (Exposure Compensation)

You can adjust overall image brightness.

1 Press the multi selector ► (◻/◻).



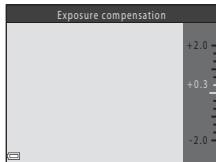

2 Select a compensation value and press the **OK** button.

- To brighten the image, set a positive (+) value.
- To darken the image, set a negative (-) value.
- The compensation value is applied, even without pressing the **OK** button.

















































Exposure Compensation Value

- The setting may not be available with some shooting modes ( 17).
- The setting applied in  (auto) mode is saved in the camera's memory even after the camera is turned off.

Default Settings

Default settings for each shooting mode are described below.

	Flash ()11	Self-timer ()14	Macro ()15	Exposure compensation ()16
 (scene auto selector)	 AUTO ¹	Off	Off ²	0.0
Scene				
 (portrait)		Off	Off ³	0.0
 (landscape)	 ³	Off	Off ³	0.0
 (sports)	 ³	Off ³	Off ³	0.0
 (night portrait)	  ⁴	Off	Off ³	0.0
 (party/indoor)	  ⁵	Off	Off ³	0.0
 (beach)	 AUTO	Off	Off ³	0.0
 (snow)	 AUTO	Off	Off ³	0.0
 (sunset)	 ³	Off	Off ³	0.0
 (dusk/dawn)	 ³	Off	Off ³	0.0
 (night landscape)	 ³	Off	Off ³	0.0
 (close-up)	 ³	Off	On ³	0.0
 (food)	 ³	Off	On ³	0.0
 (fireworks show)	 ³	Off ³	Off ³	0.0 ³
 (backlighting)	 ³	Off	Off ³	0.0
 (pet portrait)	 ³	 ⁶	Off	0.0
SE (special effects)	 ³	Off	Off	0.0
 (smart portrait)	 AUTO ⁷	Off ⁸	Off ³	0.0
 (auto)	 AUTO	Off	Off	0.0

- 1 The camera automatically selects the flash mode appropriate for the scene it has selected.  (off) can be selected manually.
- 2 The setting cannot be changed. Automatically changes to macro mode when the camera selects **Close-up**.
- 3 The setting cannot be changed.
- 4 The setting cannot be changed. The flash mode setting is fixed at fill flash with slow sync and red-eye reduction.
- 5 Slow sync with red-eye reduction flash mode may be used.
- 6 Self-timer cannot be used. Pet portrait auto release can be turned on or off (6).
- 7 Cannot be used when **Blink proof** is set to **On**.
- 8 Can be set when **Smile timer** is set to **Off**.

Functions That Cannot Be Used Simultaneously

Some functions cannot be used with other menu options.

Restricted function	Option	Description
Flash mode	Continuous (📷46)	When Continuous is selected, the flash cannot be used.
	Blink proof (📷49)	When Blink proof is set to On , the flash cannot be used.
Self-timer	Smile timer (📷48)	When Smile timer is selected, the self-timer cannot be used.
Continuous	Self-timer (📷14)	When the self-timer is used, the setting changes to Single .
Shutter sound	Continuous (📷46)	When Continuous is selected, the shutter sound is disabled.

Focusing

The focus area varies depending on the shooting mode.

Using Face Detection

In the following shooting modes, the camera uses face detection to automatically focus on human faces.

- **Portrait** or **Night portrait** in **SR** (scene auto selector) mode (👁️3)
- **Portrait** or **Night portrait** in scene mode (👁️4)
- Smart portrait mode (👁️8)

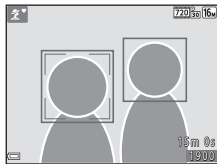

If the camera detects more than one face, a double border is displayed around the face that the camera focuses on, and single borders are displayed around the other faces.





If no faces are detected when the shutter-release button is pressed halfway, the camera focuses on the subject in the center of the frame.

✔ Notes About Face Detection

- The camera's ability to detect faces depends on a variety of factors, including the direction in which the faces are looking.
- The camera may be unable to detect faces in the following situations:
 - When faces are partially hidden by sunglasses or otherwise obstructed
 - When faces take up too much or too little of the frame

Using Skin Softening

When the shutter is released while using one of the shooting modes listed below, the camera detects human faces and processes the image to soften facial skin tones (up to three faces).

- Smart portrait mode ()
- **Portrait** or **Night portrait** in  (scene auto selector) mode ()
- **Portrait** or **Night portrait** in scene mode ()

Notes About Skin Softening

- It may take more time than usual to save images after shooting.
- Under some shooting conditions, the desired skin softening results may not be achieved, and skin softening may be applied to areas of the image where there are no faces.

Subjects Not Suitable for Autofocus



The camera may not focus as expected in the following situations. In some rare cases, the subject may not be in focus despite the fact that the focus area or the focus indicator glows green:

- Subject is very dark
- Objects of sharply differing brightness are included in the scene (e.g. the sun behind the subject makes that subject appear very dark)
- No contrast between the subject and surroundings (e.g. a portrait subject wearing a white shirt is standing in front of a white wall)
- Several objects are at different distances from the camera (e.g. the subject is inside a cage)
- Subjects with repeating patterns (window blinds, buildings with multiple rows of similarly shaped windows, etc.)
- Subject is moving rapidly

In the situations noted above, try pressing the shutter-release button halfway to refocus several times, or focus on another subject positioned at the same distance from the camera as the actual desired subject, and use focus lock ()

Focus Lock

Focus lock shooting is recommended when the camera does not activate the focus area that contains the desired subject.

1 Select  (auto) mode (10).

2 Position the subject in the center of the frame and press the shutter-release button halfway.

- Confirm that the focus area glows green.
- Focus and exposure are locked.

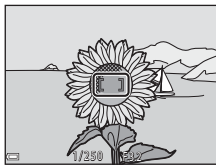

3 Without lifting your finger, recompose the picture.

- Make sure to maintain the same distance between the camera and the subject.

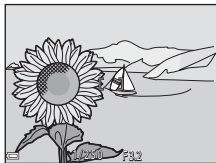

4 Press the shutter-release button the rest of the way down to take the picture.



Playback Zoom

Moving the zoom control toward **T** (Q) in full-frame playback mode (📖 17) zooms in on the image.

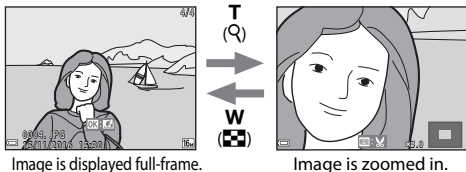

- You can change the zoom ratio by moving the zoom control toward **W** (🏴‍☠️) or **T** (Q).
- To view a different area of the image, press the multi selector ▲▼◀▶.
- When a zoomed image is displayed, press the **OK** button to return to full-frame playback mode.

Cropping Images

When a zoomed image is displayed, you can press the **MENU** button to crop the image to include only the visible portion and save it as a separate file (🔑30).

Thumbnail Playback, Calendar Display

Moving the zoom control toward **W** (📐) in full-frame playback mode (📖 17) displays images as thumbnails.



- You can change the number of thumbnails displayed by moving the zoom control toward **W** (📐) or **T** (🔍).
- While using thumbnail playback mode, press the multi selector ▲▼◀▶ to select an image and then press the **OK** button to display that image full-frame.
- While using calendar display mode, press ▲▼◀▶ to select a date and then press the **OK** button to display the images captured on that day.

✓ Notes About Calendar Display

Images captured when the camera's date is not set are treated as images captured on January 1, 2016.

Editing Still Images

Before Editing Images

You can easily edit images on this camera. Edited copies are saved as separate files.

- Edited copies are saved with the same shooting date and time as the original.



Restrictions on Image Editing

- An image can be edited up to 10 times.
- You may not be able to edit images of a certain size or with certain editing functions.

Quick Effects: Changing Hue or Mood

Quick effects type	Description
Toy camera effect 1/Toy camera effect 2/ Cross process (red)/Cross process (yellow)/ Cross process (green)/Cross process (blue)	Mainly adjusts hue and creates a different look for the image.
Soft/Fisheye/Cross screen/Miniature effect	Processes images with a variety of effects.

- 1 Display the image to which you want to apply an effect in full-frame playback mode and press the **OK** button.



- 2 Use the multi selector **▲▼◀▶** to select the desired effect and press the **OK** button.

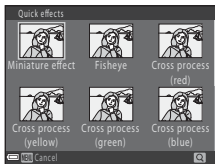

- Move the zoom control (**□** 1) toward **T** (Q) to switch to full-frame playback or **W** (⊞) to switch to thumbnail playback.
- To exit without saving the edited image, press the **MENU** button.



- 3 Select **Yes** and press the **OK** button.

- An edited copy is created.

D-Lighting: Enhancing Brightness and Contrast



Press the  button (playback mode) → select an image → MENU button → D-Lighting →  button

Use the multi selector   to select **OK** and press the  button.

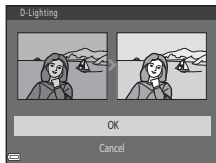
- The edited version is displayed on the right.
- To exit without saving the copy, select **Cancel** and press the  button.



Skin Softening: Softening Skin Tones

Press the  button (playback mode) → select an image → MENU button → Skin softening →  button

1 Use the multi selector ▲▼ to select the amount of effect applied and press the  button.

- The confirmation dialog is displayed with the face to which the effect was applied enlarged in the monitor.
- To exit without saving the copy, press ◀.



2 Preview the result and press the  button.



- Skin tones of up to 12 faces, in the order of that closest to the center of the frame, are softened.
- If more than one face was processed, use ◀▶ to display a different face.
- Press the MENU button to adjust the amount of effect applied. The monitor display returns to that shown in step 1.







Notes About Skin Softening

- Skin softening cannot be applied if no faces are detected in the image.
- Depending upon the direction in which faces are looking, or the brightness of faces, the camera may be unable to accurately detect faces, or the skin softening function may not perform as expected.

Small Picture: Reducing the Size of an Image

Press the  button (playback mode) → select an image → MENU button → Small picture →  button

1 Use the multi selector   to select the desired copy size and press the  button.

- For images taken at an image mode setting of  **4608×2592**, only **640×360** is displayed.

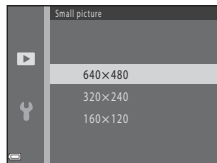

2 Select **Yes** and press the  button.

- An edited copy is created (compression ratio of approximately 1:16).

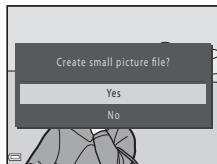

Crop: Creating a Cropped Copy

1 Move the zoom control to enlarge the image (⌘Z).

2 Refine copy composition and press the **MENU** button.

- Move the zoom control toward **T** (Q) or **W** (⌘) to adjust the zoom ratio. Set a zoom ratio at which **MENU**:⌘ is displayed.
- Use the multi selector ▲▼◀▶ to scroll the image so that only the portion to be copied is visible in the monitor.



3 Select **Yes** and press the **OK** button.

- An edited copy is created.



Image Size

When the image size of the cropped copy is 320 × 240 or smaller, the image is displayed at a smaller size during playback.

Cropping the Image in Its Current “Tall” Orientation

Use the **Rotate image** option (⌘53) to rotate the image so that it is displayed in landscape orientation. After cropping the image, rotate the cropped image back to “tall” orientation.

Connecting the Camera to a TV (Viewing Images on a TV)

Connect the camera to a TV using an audio/video cable (🔌72) to play back images or movies on the TV.

1 Turn off the camera and connect it to the TV.

- Make sure that the plugs are properly oriented. Do not insert or remove the plugs at an angle when connecting or disconnecting them.

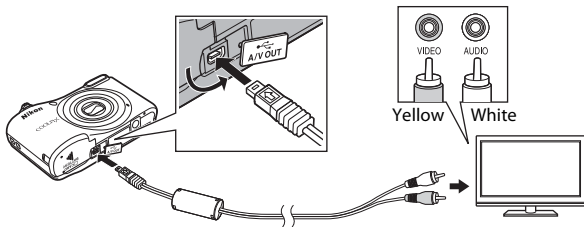

2 Set the TV's input to external video input.

- See the documentation provided with your TV for details.

3 Hold down the button to turn on the camera.

- Images are displayed on the TV.
- The camera monitor does not turn on.

If Images Are Not Displayed on the TV

Make sure that **Video mode** (🔌65) in the setup menu conforms to the standard used by your TV.

Connecting the Camera to a Printer (Direct Print)

Users of PictBridge-compatible printers can connect the camera directly to the printer and print images without using a computer.

Connecting the Camera to a Printer

- 1 Turn off the camera.
- 2 Turn on the printer.
 - Check printer settings.
- 3 Connect the camera to the printer using the USB cable.
 - Make sure that the plugs are properly oriented. Do not insert or remove the plugs at an angle when connecting or disconnecting them.

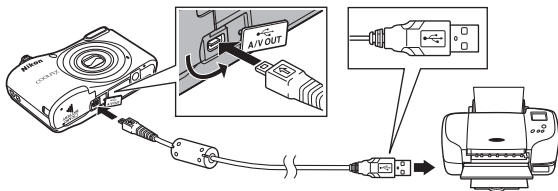

4 Turn on the camera.

- The **PictBridge** startup screen (①) is displayed in the camera monitor, followed by the **Print selection** screen (②).



Printing Individual Images

1 Connect the camera to a printer (🔗32).

2 Use the multi selector to select the desired image and press the **OK** button.

- Move the zoom control toward **W** (📷) to switch to thumbnail playback or **T** (📷) to switch to full-frame playback.



3 Use **▲▼** to select **Copies** and press the **OK** button.

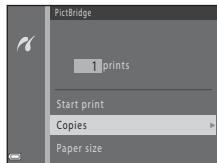

- 4** Select the desired number of copies (up to nine) and press the **OK** button.



- 5** Select **Paper size** and press the **OK** button.

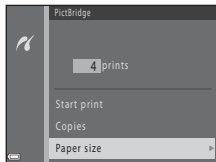

- 6** Select the desired paper size and press the **OK** button.

- To apply the paper size setting configured on the printer, select **Default** as the paper size option.
- The paper size options available on the camera vary depending on the printer that you use.

- 7** Select **Start print** and press the **OK** button.

- Printing starts.

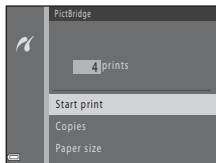

- 8** When printing is complete, turn the camera off and disconnect the USB cable.

Printing Multiple Images

- 1 Connect the camera to a printer (032).
- 2 When the **Print selection** screen is displayed, press the **MENU** button.



- 3 Use the multi selector ▲▼ to select **Paper size** and press the **OK** button.

- To exit the print menu, press the **MENU** button.

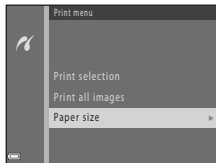

- 4 Select the desired paper size and press the **OK** button.

- To apply the paper size setting configured on the printer, select **Default** in the paper size option.
- The paper size options available on the camera vary depending on the printer that you use.

- 5 Select **Print selection** or **Print all images** and press the **OK** button.

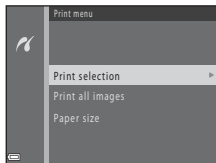

Print selection

Select images (up to 99) and the number of copies (up to nine) of each.

- Use the multi selector ◀▶ to select images, and use ▲▼ to specify the number of copies to be printed.
- Images selected for printing are indicated by 🖨️ and the numeral indicating the number of copies to be printed. If no copies have been specified for images, the selection is canceled.
- Move the zoom control toward T (🔍) to switch to full-frame playback or W (🖼️) to switch to thumbnail playback.
- Press the Ⓞ button when setting is complete.
- When the screen shown on the right is displayed, select **Start print** and press the Ⓞ button to start printing.

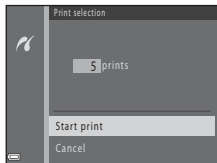

Print all images

One copy each of all images saved in the internal memory, or on the memory card, is printed.

- When the screen shown on the right is displayed, select **Start print** and press the Ⓞ button to start printing.

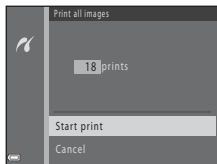

- 6 When printing is complete, turn the camera off and disconnect the USB cable.

Recording Movies

- When no memory card is inserted (i.e., when using the camera's internal memory), **Movie options** (🔑55) is set to **480P 480/30p** or **240P 240/30p**. **720P 720/30p** cannot be selected.

1 Display the shooting screen.

- Check the remaining amount of movie recording time.
- If **Photo info** in the **Monitor settings** (🔑60) in the setup menu is set to **Movie frame+auto info**, the area that will be visible in the movie can be confirmed before movie recording starts.
- When recording movies, the angle of view (i.e., the area visible in the frame) is narrower compared to that of still images.

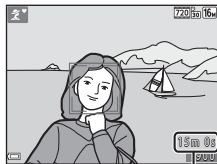

Movie recording time remaining

2 Press the **●** (📹 movie-record) button to start movie recording.

- The camera focuses on the subject in the center of the frame.

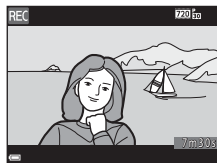
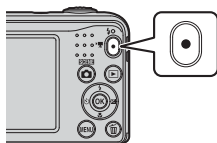

3 Press the **●** (📹 movie-record) button again to stop recording.

Maximum Movie Length



Individual movie files cannot exceed 4 GB in size or 29 minutes in length, even when there is sufficient free space on the memory card for longer recording.

- The maximum movie length for a single movie is displayed on the shooting screen.
- Recording may end before either limit is reached if camera temperature becomes elevated.
- The actual movie length may vary depending on the movie content, subject movement, or type of memory card.

Notes About Saving Images and Recording Movies

The indicator showing the number of exposures remaining or the indicator showing the maximum movie length flashes while images are being saved or while a movie is being recorded. **Do not open the battery-chamber/memory card slot cover or remove the batteries or memory card** while an indicator is flashing. Doing this could result in loss of data, or in damage to the camera or the memory card.

Notes About Movie Recording

- Memory cards with an SD Speed Class rating of 6 or faster are recommended when recording movies (:19). Movie recording may stop unexpectedly when memory cards with a lower Speed Class rating are used.
- The optical zoom ratio cannot be changed once recording starts.
- Use the zoom control to operate digital zoom while recording movies. The zoom range is between the optical zoom ratio before recording a movie and up to 4x.
- There may be some degradation in image quality when digital zoom is used.
- The sounds of zoom control operation, autofocus lens drive movement, and aperture operation when brightness changes may be recorded.
- Smear (:3) visible in the monitor with movie recording is recorded with movies. Avoiding bright objects such as the sun, reflections of the sun, and electric lights is recommended.
- Depending on the distance to the subject or the amount of zoom applied, subjects with repeating patterns (fabrics, lattice windows, etc.) may have colored stripes (interference patterns, moire, etc.) in them during movie recording and playback. This occurs when the pattern in the subject and the layout of the image sensor interfere with each other; it is not a malfunction.

✓ Camera Temperature

- The camera may become warm when shooting movies for an extended period of time or when the camera is used in a hot area.
- If the inside of the camera becomes extremely hot when recording movies, the camera will automatically stop recording.

The amount of time remaining until the camera stops recording (🔥 10s) is displayed.

After the camera stops recording, it turns itself off.

Leave the camera off until the inside of the camera has cooled.

✓ Notes About Autofocus

Autofocus may not perform as expected (🔍 21). Should this occur, try the following:

1. Set **Autofocus mode** in the movie menu to **Single AF** (default setting) before starting movie recording.
2. Frame another subject—positioned at the same distance from the camera as the intended subject—in the center of the frame, press the ● (📹 movie-record) button to start recording, and then modify the composition.

Playing Back Movies

Press the ▶ button to enter playback mode.

Movies are indicated by the movie options icon (📹 55).

Press the ⓧ button to play back movies.

- To adjust the volume, move the zoom control (📖 1).

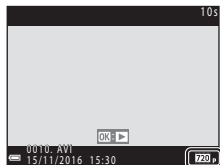

Movie options

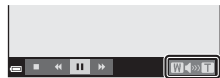

Volume indicator

Functions Available During Playback

Playback controls are displayed in the monitor.

The operations listed below can be performed by using the multi selector ◀▶ to select a control and then pressing the OK button.



Function	Icon	Description	
Rewind	◀	Hold down the OK button to rewind the movie.	
Advance	▶	Hold down the OK button to advance the movie.	
Pause	⏸	Pause playback. The operations listed below can be performed while paused.	
		◀	Rewind the movie one frame. Hold down the OK button for continuous rewinding.
		▶	Advance the movie one frame. Hold down the OK button for continuous advancing.
	▶	Resume playback.	
End	■	Return to full-frame playback mode.	

Options Available in the Shooting Menu

The settings listed below can be changed by pressing the **MENU** button during shooting.

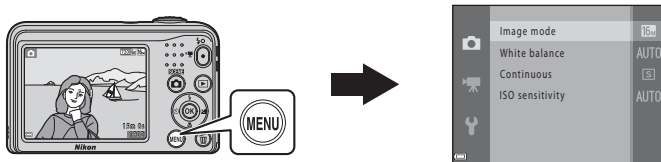

The settings that can be changed vary depending on the shooting mode, as shown below.

	Scene auto selector mode	Scene	Special effects	Smart portrait	Auto mode
Image mode (📷42)	✓	✓	✓	✓	✓
White balance (📷44)	-	-	-	-	✓
Continuous (📷46)	-	-	-	-	✓
ISO sensitivity (📷47)	-	-	-	-	✓
Skin softening (📷48)	-	-	-	✓	-
Smile timer (📷48)	-	-	-	✓	-
Blink proof (📷49)	-	-	-	✓	-

The Shooting Menu (for (Auto) Mode)

Image Mode Settings (Image Size and Quality)

Enter shooting mode → MENU button → Shooting menu → Image mode →  button

Select the combination of image size and compression ratio that is used when saving images. The higher the image mode setting, the larger the size at which images can be printed, and the lower the compression ratio, the higher the quality of the images, but the number of images that can be saved is reduced.

Option*	Compression ratio	Aspect ratio (horizontal to vertical)
16M* 4608×3456★	Approx. 1:4	4:3
16M 4608×3456 (default setting)	Approx. 1:8	4:3
8M 3264×2448	Approx. 1:8	4:3
4M 2272×1704	Approx. 1:8	4:3
2M 1600×1200	Approx. 1:8	4:3
VGA 640×480	Approx. 1:8	4:3
16:9 12M 4608×2592	Approx. 1:8	16:9

* The total number of pixels captured, and the number of pixels captured horizontally and vertically.
Example: **16M 4608×3456** = approx. 16 megapixels, 4608 × 3456 pixels

Notes About Image Mode

- The image mode setting can also be changed in shooting modes other than  (auto) mode. The changed setting is also applied to other shooting modes.
- The setting may not be changed when using certain settings of other functions.

Number of Images That Can Be Saved







- The approximate number of images that can be saved can be checked in the monitor when shooting ( 11).
- Note that due to JPEG compression, the number of images that can be saved may vary greatly depending on the image content, even when using memory cards with the same capacity and the same image mode setting. In addition, the number of images that can be saved may vary depending on the make of the memory card.
- If the number of exposures remaining is 10,000 or more, the number of exposures remaining display shows “9999”.

White Balance (Adjusting Hue)



Select  (auto) mode → MENU button → White balance →  button

Adjust white balance to suit the light source or weather conditions in order to make the colors in images match what you see with your eyes.

- Use **Auto** under most conditions. Change the setting when you want to adjust the hue of the image you are taking.

Option	Description
AUTO Auto (default setting)	White balance is automatically adjusted to suit lighting conditions.
PRE Preset manual	Use when the desired result is not achieved with Auto , Incandescent , etc. ( 45).
 Daylight	White balance adjusted for direct sunlight.
 Incandescent	Use under incandescent lighting.
 Fluorescent	Use under fluorescent lighting.
 Cloudy	Use when taking images under overcast skies.
 Flash	Use with the flash.

Notes About White Balance

- Set the flash to  (off) when white balance is set to any setting other than **Auto** and **Flash** (11).
- The setting may not be changed when using certain settings of other functions.

Using Preset Manual

Use the procedure below to measure the white balance value under the lighting used during shooting.

1 Place a white or gray reference object under the lighting that will be used during shooting.

2 Use the multi selector ▲▼ to select **Preset manual** in the **White balance** menu, and press the **OK** button.

- The camera zooms in to the position for measuring white balance.

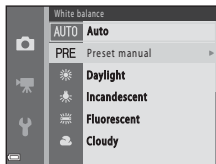

3 Select **Measure** and frame the reference object in the measuring window.

- To apply the last measured value, select **Cancel** and press the **OK** button.

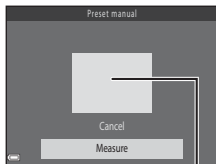

Measuring window



4 Press the **OK** button to measure the value.



- The shutter is released and measurement is complete. No image is saved.

✓ Notes About Preset Manual

A value for flash lighting cannot be measured with **Preset manual**. When shooting using the flash, set **White balance** to **Auto** or **Flash**.

Continuous Shooting



Select  (auto) mode → MENU button → Continuous →  button

Option	Description
 Single (default setting)	One image is taken each time the shutter-release button is pressed.
 Continuous	While the shutter-release button is held all the way down, images are captured continuously. <ul style="list-style-type: none">The frame rate for continuous shooting is about 1.2 fps and the maximum number of continuous shots is about 6 (when image mode is set to  4608x3456).

Notes About Continuous Shooting

- When **Continuous** is selected, the flash cannot be used. Focus, exposure, and white balance are fixed at the values determined with the first image in each series.
- The frame rate for continuous shooting may vary depending upon the current image mode setting, the memory card used, or shooting condition.
- The setting may not be changed when using certain settings of other functions.

ISO Sensitivity

Select  (auto) mode → MENU button → ISO sensitivity → 

A higher ISO sensitivity allows darker subjects to be captured. Additionally, even with subjects of similar brightness, pictures can be taken at faster shutter speeds, and blurring caused by camera shake and subject movement can be reduced.

- When a higher ISO sensitivity is set, images may contain noise.

Option	Description
AUTO Auto (default setting)	Sensitivity is automatically selected from the range of ISO 80 to 1600.
80, 100, 200, 400, 800, 1600	Sensitivity is locked at the specified value.

ISO Sensitivity Display on the Shooting Screen

When **Auto** is selected, **ISO** is displayed when the ISO sensitivity increases.

The Smart Portrait Menu

- See “Image Mode Settings (Image Size and Quality)” (📷42) for information about **Image mode**.

Skin Softening

Enter smart portrait mode → MENU button → Skin softening → Ⓚ button

Option	Description
 On (default setting)	When the shutter is released, the camera detects one or more human faces (up to three), and processes the image to soften facial skin tones before saving the image.
Off	Turns skin softening off.

The result of skin softening effect on your subject cannot be confirmed when framing images for shooting. Check the results in playback mode, after taking images.

Smile Timer

Enter smart portrait mode → MENU button → Smile timer → Ⓚ button

The camera detects human faces and then automatically releases the shutter whenever a smile is detected.

Option	Description
 On (default setting)	Enables the smile timer.
Off	Turns the smile timer off.

Blink Proof

Enter smart portrait mode → MENU button → Blink proof →  button

Option	Description
 On	<p>The camera automatically releases the shutter twice with every shot and saves one image in which the subject's eyes are open.</p> <ul style="list-style-type: none">• If the camera saved an image in which the subject's eyes may have been closed, A blink was detected in the picture just taken. is displayed for a few seconds.• The flash cannot be used.
Off (default setting)	Turns the blink proof off.

The Playback Menu

- See “Editing Still Images” (🔧25) for information about image editing functions.

Slide Show

Press the  button (playback mode) → MENU button → Slide show →  button



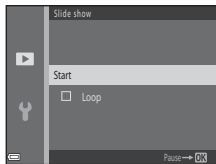

Play back images one by one in an automated “slide show.” When movie files are played back in the slide show, only the first frame of each movie is displayed.

1 Use the multi selector to select **Start** and press the button.

- The slide show begins.
- To repeat the slide show automatically, select **Loop** and press the  button before selecting **Start**.
- The maximum playback time is up to about 30 minutes even if **Loop** is enabled.



2 Select End or Restart.



- The screen shown on the right is displayed after the slide show ends or is paused. To exit the show, select  and then press the  button. To resume the slide show, select  and then press the  button.



Operations During Playback

- Use   to display the previous/next image. Press and hold to rewind/fast forward.
- Press the  button to pause or end the slide show.

Protect

Press the  button (playback mode) → MENU button → Protect →  button

The camera protects selected images from accidental deletion.

Select images to protect or cancel protection for previously protected images from the image selection screen (52).

Note that formatting the camera's internal memory or the memory card permanently deletes protected files (65).

The Image Selection Screen

When an image selection screen such as the one shown on the right is displayed while operating the camera, follow the procedures described below to select the images.



1 Use the multi selector ◀▶ to select an image.

- Move the zoom control (1) toward **T** (Q) to switch to full-frame playback or **W** (R) to switch to thumbnail playback.
- When selecting an image for **Rotate image**, or when using the **Print selection** screen to print individual images, only one image can be selected. Proceed to step 3.



2 Use ▲▼ to select or deselect (or to specify the number of copies).

- When an image is selected, an icon is displayed with the image. Repeat steps 1 and 2 to select additional images.





3 Press the Ⓞ button to apply image selection.

- When **Selected images** is selected, a confirmation dialog is displayed. Follow the instructions displayed in the monitor.

Rotate Image

Press the  button (playback mode) → MENU button → Rotate image →  button

Specify the orientation in which saved images are displayed during playback. Still images can be rotated 90 degrees clockwise or 90 degrees counterclockwise.

Select an image from the image selection screen (52). When the Rotate image screen is displayed, press the multi selector  to rotate the image 90 degrees.



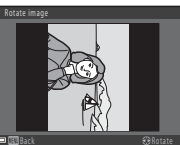
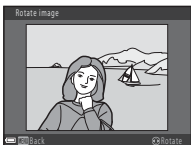

Rotate 90 degrees
counterclockwise



Rotate 90 degrees
clockwise

Press the  button to finalize display orientation, and save orientation information with the image.

Copy (Copy Between Internal Memory and Memory Card)

Press the  button (playback mode) → MENU button → Copy →  button

Copy images between the internal memory and a memory card.

- 1 Use the multi selector ▲▼ to select a destination option to which images are copied and press the  button.

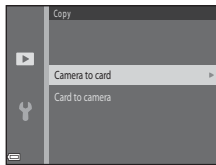

- 2 Select a copy option and press the  button.

- If you choose the **Selected images** option, use the image selection screen to specify images (52).

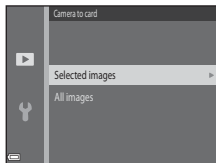

Notes About Copying Images

- Only files in formats that this camera can record can be copied.
- Operation is not guaranteed with images captured with another make of camera or that have been modified on a computer.

Copying to a Memory Card That Contains No Images

When the camera is switched to playback mode, **Memory contains no images.** is displayed. Press the MENU button to select **Copy.**



The Movie Menu



Movie Options

Enter shooting mode → MENU button →  menu icon → Movie options →  button

Select the desired movie option to record.

- Memory cards (Class 6 or higher) are recommended for recording movies (:19).



Option (Image size/Frame rate, File format)	Image size	Aspect ratio (horizontal to vertical)
 720/30p (default setting*)	1280 × 720	16:9
 480/30p	640 × 480	4:3
 240/30p	320 × 240	4:3

* When no memory card is inserted (i.e., when using the camera's internal memory), the setting is  **480/30p** or  **240/30p**.

Autofocus Mode

Enter shooting mode → MENU button →  menu icon → Autofocus mode →  button

Set how the camera focuses in movie mode.







Option	Description
AF-S Single AF (default setting)	Focus is locked when the  (● ) button is pressed to start recording. Select this option when the distance between the camera and the subject will remain fairly consistent.
AF-F Full-time AF	Camera focuses continuously. Select this option when the distance between the camera and subject will change significantly during recording. The sound of the camera focusing may be heard in the recorded movie. Use of Single AF is recommended to prevent the sound of the camera focusing from interfering with recording.

The Setup Menu

Time Zone and Date

MENU button →  menu icon → Time zone and date →  button

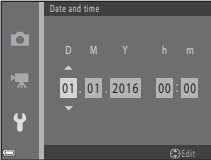
Set the camera clock.

Option	Description
Date and time	<ul style="list-style-type: none">Use   to select a field and then use   to set the date and time.Select the minute field and then press the  button to finish. 
Date format	Select Year/Month/Day , Month/Day/Year , or Day/Month/Year .
Time zone	Set time zone and daylight saving time. <ul style="list-style-type: none">When Travel destination () is set after having set the home time zone () , the time difference between the travel destination and the home time zone is automatically calculated, and the date and time are saved for the selected region.

Setting the Time Zone

- 1 Use the multi selector ▲▼ to select **Time zone** and press the **OK** button.

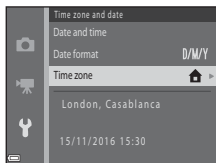

- 2 Select **Home time zone** or **Travel destination** and press the **OK** button.

- The date and time displayed in the monitor changes depending on whether the home time zone or travel destination is selected.

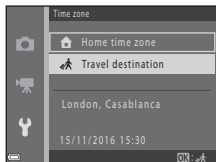

- 3 Press **▶**.

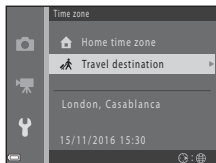

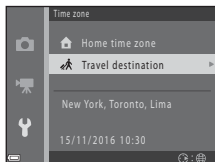
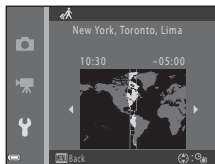

4 Use ◀▶ to select the time zone.

- Press ▲ to enable daylight saving time function, and ☀ is displayed. Press ▼ to disable the daylight saving time function.
- Press the OK button to apply the time zone.
- If the correct time is not displayed for the home or travel destination time zone setting, set the appropriate time in **Date and time**.







Monitor Settings

MENU button →  menu icon → Monitor settings →  button



Option	Description
Photo info	Set whether or not to display information in the monitor.
Brightness	Select from five settings. <ul style="list-style-type: none">• Default setting: 3

Photo Info

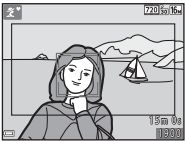
	Shooting mode	Playback mode
Show info		
Auto info (default setting)	Current settings and operation guide are displayed as in Show info . If no operations are performed for a few seconds, the information is hidden as in Hide info . Information is displayed again when the next operation is performed.	
Hide info		



	Shooting mode	Playback mode
Framing grid+auto info	 <p>In addition to information shown with Auto info, a framing grid is displayed to help frame images. The framing grid is not displayed when recording movies.</p>	The current settings or operation guide is displayed as in Auto info .
Movie frame+auto info	 <p>In addition to information shown with Auto info, a frame is displayed before recording begins that represents the area that will be captured when recording movies. The movie frame is not displayed when recording movies.</p>	The current settings or operation guide is displayed as in Auto info .

Date Stamp

MENU button →  menu icon → Date stamp →  button

The shooting date and time can be imprinted on the images when shooting, allowing the information to be printed even from printers that do not support date printing.





Option	Description
 Date	Date is imprinted on images.
 Date and time	Date and time are imprinted on images.
Off (default setting)	Date and time are not imprinted on images.



Notes About Date Stamp



- Imprinted dates form a permanent part of image data and cannot be deleted. The date and time cannot be imprinted on images after they have been captured.
- The date and time cannot be imprinted in the following situations:
 - When using **Pet portrait** (when  **Continuous** is selected) scene mode
 - When shooting movies
- The imprinted date and time may be difficult to read when using a small image size.

Electronic VR







MENU button →  menu icon → Electronic VR →  button

Select the electronic VR (vibration reduction) setting used when shooting.



Option	Description
 On	<p>In the following conditions, the effects of camera shake are reduced when shooting still images.</p> <ul style="list-style-type: none">• When the flash mode is set to  (off) or  SLOW (slow sync)• When the shutter speed is slow• When the subject is dark <p>Vibration reduction is always applied during movie recording.</p>
Off (default setting)	Electronic VR is disabled.

When **On** is selected, electronic VR is applied according to the shooting conditions while  is displayed in the shooting screen ( 3).

Notes About Electronic VR

- Electronic VR is disabled while the flash is used, except when using slow sync mode.
- Electronic VR cannot be used when using the following scene modes.
 - Sports ()5
 - Night portrait ()5
 - Dusk/dawn ()4
 - Night landscape ()4
 - Fireworks show ()6
 - Backlighting ()6
 - Pet portrait ()6
- The effectiveness of electronic VR decreases as camera shake increases.
- The images captured may be somewhat “grainy” in appearance.

Sound Settings

MENU button →  menu icon → Sound settings →  button

Option	Description
Button sound	When On (default setting) is selected, the camera produces one beep when operations are performed, two beeps when focus is acquired on the subject, and three beeps when an error occurs. The start-up sound is also produced. <ul style="list-style-type: none">• Sounds are disabled when using Pet portrait scene mode.
Shutter sound	When On (default setting) is selected, the shutter sound is produced when the shutter is released. <ul style="list-style-type: none">• The shutter sound is not produced when using continuous shooting mode, when recording movies, or when using Pet portrait scene mode.

Auto Off

MENU button →  menu icon → Auto off →  button



Set the amount of time that elapses before the camera enters standby mode ( 12). You can select **30 s** (default setting), **1 min**, **5 min**, or **30 min**.

Notes About Auto Off

The time that passes before the camera enters standby mode is fixed in the following situations:

- When a menu is displayed: 3 minutes
- When the audio/video cable is connected: 30 minutes

Format Memory/Format Card



MENU button →  menu icon → Format memory/Format card →  button

Use this option to format the internal memory or a memory card.

Formatting the internal memory or memory cards permanently deletes all data. Data that has been deleted cannot be recovered. Make sure to transfer important images to a computer before formatting.



- Do not turn the camera off or open the battery-chamber/memory card slot cover during formatting.
- To format the camera's internal memory, remove the memory card. The **Format memory** option is displayed in the setup menu.
- To format a memory card, insert the memory card into the camera. The **Format card** option is displayed in the setup menu.

Language

MENU button →  menu icon → Language →  button

Select a language for display of camera menus and messages.

Video Mode

MENU button →  menu icon → Video mode →  button

Adjust settings for connection to a TV.

Select from **NTSC** and **PAL**.

Both **NTSC** and **PAL** are standards for analog color television broadcasting.

Reset All

MENU button →  menu icon → Reset all →  button

When **Reset** is selected, the camera's settings are restored to their default values.



- Some settings, such as **Time zone and date** or **Language**, are not reset.







Resetting File Numbering

To reset file numbering to "0001", delete all images saved in the internal memory or on the memory card ( 18) before selecting **Reset all**.



Battery Type

MENU button →  menu icon → Battery type →  button

To ensure that the camera shows the correct battery level ( 11), select the type that matches the batteries currently in use.

Option	Description
 Alkaline (default setting)	LR6/L40 (AA-size) alkaline batteries
 COOLPIX (Ni-MH)	Nikon EN-MH2 rechargeable Ni-MH (nickel metal hydride) batteries
 Lithium	FR6/L91 (AA-size) lithium batteries









Firmware Version









MENU button →  menu icon → Firmware version →  button







View the current camera firmware version.

Error Messages

Refer to the table below if an error message is displayed.

Display	Cause/Solution	
Memory card is write protected.	The write-protect switch is in the "lock" position. Slide the write-protect switch to the "write" position.	—
This card cannot be used.	An error occurred while accessing the memory card. <ul style="list-style-type: none"> • Use an approved card. • Check that the terminals are clean. • Confirm that the memory card is correctly inserted. 	6,  19
This card cannot be read.		
Card is not formatted. Format card?	The memory card has not been formatted for use in the camera. Formatting deletes all data saved on the memory card. If you need to keep copies of any images, make sure to select No and save the copies to a computer or other medium before formatting the memory card. Select Yes and press the  button to format the memory card.	 6
Out of memory.	Delete images or insert a new memory card.	6, 18
Image cannot be saved.	An error occurred while saving the image. Insert a new memory card or format the internal memory or memory card.	 65
	The camera has run out of file numbers. Insert a new memory card or format the internal memory or memory card.	 65
	There is insufficient space to save the copy. Delete images from the destination.	18
Image cannot be modified.	Select images that support the editing function.	 25,  13

Display	Cause/Solution	
Cannot record movie.	A time-out error occurred while saving the movie on the memory card. Select a memory card with a faster write speed.	 38,  19
Memory contains no images.	There are no images in the internal memory or on the memory card. <ul style="list-style-type: none"> Remove the memory card from the camera to play back images in the camera's internal memory. To copy the images saved in the camera's internal memory to the memory card, press the MENU button to select Copy in the playback menu. 	8  54
File contains no image data.	The file was not created or edited with this camera. The file cannot be viewed on this camera. View the file using a computer or the device used to create or edit this file.	–
All images are hidden.	There are no images available for a slide show.	 50
This image cannot be deleted.	The image is protected. Disable protection.	 51
Lens error. Try again after turning the camera off and on.	If the error persists, contact your retailer or Nikon-authorized service representative.	9
Communications error	An error occurred while communicating with the printer. Turn the camera off and reconnect the USB cable.	 32
System error	An error occurred in the camera's internal circuitry. Turn the camera off, remove and reinsert the batteries, and turn the camera on. If the error persists, contact your retailer or Nikon-authorized service representative.	6, 9
Printer error: check printer status.	After solving the problem, select Resume and press the  button to resume printing.*	–
Printer error: check paper.	Load the specified size of paper, select Resume , and press the  button to resume printing.*	–

Display	Cause/Solution	
Printer error: paper jam.	Remove the jammed paper, select Resume , and press the  button to resume printing.*	–
Printer error: out of paper.	Load the specified size of paper, select Resume , and press the  button to resume printing.*	–
Printer error: check ink.	There is a problem with the printer's ink. Check the ink, select Resume , and press the  button to resume printing.*	–
Printer error: out of ink.	Replace the ink cartridge, select Resume , and press the  button to resume printing.*	–
Printer error: file corrupt.	There is a problem with the image file to be printed. Select Cancel and press the  button to cancel printing.	–

* See the documentation provided with your printer for further guidance and information.

File Names

Images or movies are assigned file names as follows.

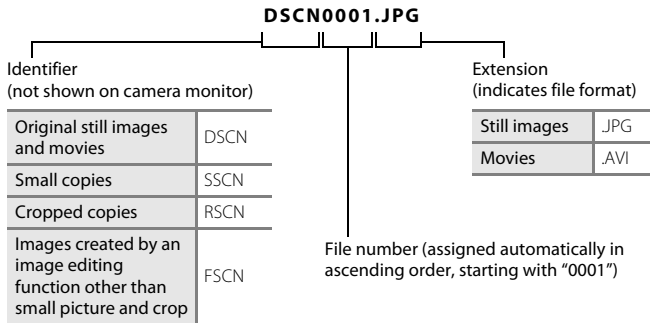

Optional Accessories

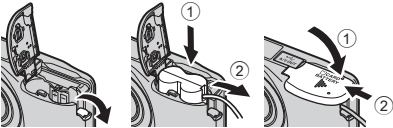
Rechargeable battery	Rechargeable Ni-MH batteries EN-MH2-B2 (set of two EN-MH2 batteries)* Rechargeable Ni-MH batteries EN-MH2-B4 (set of four EN-MH2 batteries)*
Battery charger	Battery Charger MH-72 (includes two EN-MH2 rechargeable Ni-MH batteries)* Battery Charger MH-73 (includes four EN-MH2 rechargeable Ni-MH batteries)*
AC adapter	<p>AC Adapter EH-65A (connect as shown)</p>  <p>Make sure that the power connector cord has been properly aligned in the battery-chamber groove before closing the battery-chamber/memory card slot cover. If part of the cord runs out of the groove, the cover or cord may be damaged when the cover is closed.</p>
USB cable	USB Cable UC-E16
Audio/video cable	Audio Video Cable EG-CP14

* To charge EN-MH2 batteries, use only Battery Charger MH-72 or MH-73. Do not use these battery chargers to charge any other type of battery.

Availability may vary with country or region.

See our website or brochures for the latest information.



Technical Notes and Index

Caring for the Product	2
The Camera.....	2
Batteries	4
Memory Cards	6
Cleaning and Storage	7
Cleaning.....	7
Storage.....	7
Troubleshooting	8
Specifications	15
Applicable Memory Cards.....	19
Index	21

Caring for the Product

The Camera

To ensure continued enjoyment of this Nikon product, observe the precautions described below in addition to the warnings in "For Your Safety" (📖 vii - x) when using or storing the device.

✔ Do Not Drop

The product may malfunction if subjected to strong shock or vibration.

✔ Handle the Lens and All Moving Parts with Care

Do not apply force to the lens, lens cover, monitor, memory card slot, or battery chamber. These parts are easily damaged. Applying force to the lens cover could result in camera malfunction or damage to the lens. Should the monitor break, care should be taken to avoid injury caused by broken glass and to prevent the liquid crystal from the display touching the skin or entering the eyes or mouth.

✔ Keep Dry

The device will be damaged if immersed in water or subjected to high humidity.

✔ Avoid Sudden Changes in Temperature

Sudden changes in temperature, such as when entering or leaving a heated building on a cold day, can cause condensation to form inside the device. To prevent condensation, place the device in a carrying case or a plastic bag before exposing it to sudden changes in temperature.

✔ Keep away from Strong Magnetic Fields

Do not use or store this device in the vicinity of equipment that generates strong electromagnetic radiation or magnetic fields. Strong static charge or the magnetic fields produced by equipment such as radio transmitters could interfere with the monitor, damage data saved on the memory card, or affect the product's internal circuitry.

Do Not Point the Lens at Strong Light Sources for Extended Periods

Avoid pointing the lens at the sun or other strong light sources for extended periods when using or storing the camera. Intense light may cause deterioration of the image sensor, producing a white blur effect in photographs.

Turn the Product off Before Removing or Disconnecting the Power Source

Do not remove the batteries while the product is on, or while images are being saved or deleted. Forcibly cutting power in these circumstances could result in loss of data or in damage to product memory or internal circuitry.

Notes About the Monitor

- Monitors and electronic viewfinders are constructed with extremely high precision; at least 99.99% of pixels are effective, with no more than 0.01% being missing or defective. Hence while these displays may contain pixels that are always lit (white, red, blue, or green) or always off (black), this is not a malfunction and has no effect on images recorded with the device.
- Images in the monitor may be difficult to see under bright lighting.
- The monitor is lit by an LED backlight. Should the monitor begin to dim or flicker, contact your Nikon-authorized service representative.

Notes About Smear

White or colored streaks may be visible when bright subjects are framed in the monitor. This phenomenon, known as “smear,” occurs when extremely bright light strikes the image sensor; it is characteristic of image sensors and does not indicate a malfunction. Smear may also take the form of partial discoloration in the monitor during shooting. It does not appear in images saved with the camera except in the case of movies. When shooting movies, we recommend that you avoid bright subjects such as the sun, reflected sunlight, and electric lights.

Batteries

Be sure to read and follow the warnings in "For Your Safety" (📖 vii-x) before use.

✔ Notes About Using Batteries

- Used batteries may overheat. Handle with caution.
- Do not use batteries beyond their recommended expiration date.
- Do not turn the camera on and off repeatedly if discharged batteries are inserted in the camera.

✔ Spare Batteries

We recommend carrying spare batteries depending on where you are shooting. It may be difficult to purchase batteries in certain areas.

✔ Charging Batteries

If using optional rechargeable batteries, charge the batteries before taking pictures. Batteries are not charged at the time of purchase.

Be sure to read and follow the warnings noted in the operating instructions included with the battery charger.

✔ Charging Rechargeable Batteries

- Do not mix batteries with different amounts of charge remaining, or batteries of a different make or model.
- When using EN-MH2 batteries with this camera, charge two batteries at a time using Battery Charger MH-72. When using Battery Charger MH-73, charge two or four batteries at a time. Use only Battery Charger MH-72 or MH-73 to charge EN-MH2 batteries.
- When using Battery Charger MH-72 or MH-73, only charge EN-MH2 batteries.

✔ Notes About EN-MH1 Rechargeable Batteries and Battery Charger MH-70/71

- You can also use EN-MH1 Ni-MH rechargeable batteries with this camera.
- Use only Battery Charger MH-70 or MH-71 to charge EN-MH1 batteries.
- When using Battery Charger MH-70 or MH-71, only charge EN-MH1 batteries.
- Set the **Battery type** setting (📖 25, 🎛️ 66) in the setup menu to **COOLPIX (Ni-MH)**.

Notes About Rechargeable Ni-MH Batteries

- If you repeatedly charge rechargeable Ni-MH batteries while they still have some charge remaining, the message **Battery exhausted.** may be displayed prematurely when using the batteries. This is due to the “memory effect,” in which the amount of charge the batteries can hold decreases temporarily. Use the batteries until there is no charge remaining and they will return to their normal behavior.
- Rechargeable Ni-MH batteries discharge even when not being used. We recommend charging the batteries just before using them.

Cold Environment Usage

Battery performance decreases in cold environments. When using the camera in cold environments, try not to let the camera and batteries become too cold. The camera may not function if you use discharged batteries in cold environments. Keep spare batteries warm and alternate between two sets of batteries. Batteries that cannot be used because they have become too cold can often be used again when they have been warmed up.

Battery Terminals

Dirt on the battery terminals can prevent the camera from functioning. Remove dirt from the terminals using a dry cloth.

Remaining Battery Charge

If you insert discharged batteries into the camera, the camera may indicate that the batteries have adequate charge remaining. This is a characteristic of batteries.

Recycling

Used batteries are a valuable resource. Please recycle used batteries in accordance with local regulations. Cover the battery terminals with plastic tape when recycling.

Memory Cards

- Use only Secure Digital memory cards (SD:19).
- Observe the precautions noted in the documentation included with your memory card.
- Do not affix labels or stickers to the memory card.
- Do not format the memory card using a computer.
- The first time you insert a memory card that has been used in another device into this camera, be sure to format it with this camera. We recommend formatting new memory cards with this camera before using them with this camera.
- Note that **formatting a memory card permanently deletes all images and other data on the memory card**. If there is data saved on the memory card that you wish to keep, copy that data to a computer before formatting.
- If the message **Card is not formatted. Format card?** is displayed when the camera is turned on, the memory card must be formatted. If there is data on the memory card that you do not want to delete, select **No** and press the **OK** button. Copy that data to a computer before formatting. To format the memory card, select **Yes**.
- Observe the following precautions while formatting the memory card, saving and deleting images, and copying images to a computer, otherwise data on the memory card itself may be damaged.
 - Do not open the battery-chamber/memory card slot cover or remove the memory card or batteries.
 - Do not turn off the camera.
 - Do not disconnect the AC adapter.

Cleaning and Storage

Cleaning

Do not use alcohol, thinner, or other volatile chemicals.

Lens	Avoid touching glass parts with your fingers. Remove dust or lint with a blower (typically a small device with a rubber bulb attached to one end that is pumped to produce a stream of air out the other end). To remove fingerprints or other stains that cannot be removed with a blower, wipe the lens with a soft cloth, using a spiral motion that starts at the center of them and working toward the edges. If this fails, clean the lens using a cloth lightly dampened with commercial lens cleaner.
Monitor	Remove dust or lint with a blower. To remove fingerprints and other stains, clean the monitor with a soft, dry cloth, being careful not to apply pressure.
Body	Use a blower to remove dust, dirt, or sand, then wipe gently with a soft, dry cloth. After using the camera at the beach or other sandy or dusty environment, wipe off any sand, dust, or salt with a dry cloth lightly dampened with fresh water and dry thoroughly. Note that foreign matter inside the camera could cause damage not covered by the warranty.

Storage

Turn the camera off when not in use. Be sure that the power-on lamp is off before putting the camera away. Remove the batteries if the camera will not be used for an extended period. Do not store the camera with naphtha or camphor moth balls, or in any of the following locations:

- Next to equipment that produces strong electromagnetic fields, such as televisions or radios
- Exposed to temperatures below -10°C (14°F) or above 50°C (122°F)
- Places that are poorly ventilated or subject to humidity of over 60%









To prevent mold or mildew, take the camera out of storage at least once a month. Turn the camera on and release the shutter a few times before putting the camera away again.





For storing the batteries, follow the precautions in "Batteries" (🔋:4) in "Caring for the Product" (🔧:2).

Troubleshooting













If the camera fails to function as expected, check the list of common problems below before consulting your retailer or Nikon-authorized service representative.

















Power, Display, Settings Issues





















Problem	Cause/Solution	
The camera is on but does not respond.	Wait for recording to end. If the problem persists, turn the camera off. If the camera does not turn off, remove and reinsert the battery or batteries or, if you are using an AC adapter, disconnect and reconnect the AC adapter. Note that although any data currently being recorded will be lost, data that have already been recorded will not be affected by removing or disconnecting the power source.	6, 9,  72
Camera turns off without warning.	<ul style="list-style-type: none">• The camera automatically turns off to save power (auto off function).• The camera or batteries have become too cold and cannot operate properly.• The inside of the camera has become hot. Leave the camera off until the inside of the camera has cooled, and then try turning it on again.	12  5 –
Monitor is blank.	<ul style="list-style-type: none">• The camera is off.• The batteries are exhausted.• The camera has entered standby mode to save power. Press the power switch, shutter-release button,  button,  button, or  (movie-record) button.• The flash lamp flashes while the flash is charging. Wait for the flash to charge.• The camera and computer are connected via a USB cable.• The camera and TV are connected via an audio/video cable.	9 11 1, 12 2,  13 27, 30 27,  31

Problem	Cause/Solution	
Monitor is hard to read.	<ul style="list-style-type: none"> • Select Monitor settings > Brightness in the setup menu and adjust the monitor brightness. • The monitor is dirty. Clean the monitor. 	25,  60  7
Date and time of recording are not correct.	<ul style="list-style-type: none"> • If the camera clock has not been set,  flashes during shooting and movie recording. Images and movies saved before the clock is set are dated "00/00/0000 00:00" or "01/01/2016 00:00" respectively. Set the correct time and date from the Time zone and date option in the setup menu. • The camera clock is not as accurate as ordinary watches or clocks. Periodically compare the time of the camera clock with that of a more accurate timepiece and reset as required. 	9, 25,  57
No indicators displayed in monitor.	Hide info is selected for Photo info in Monitor settings in the setup menu.	25,  60
Date stamp not available.	Time zone and date has not been set in the setup menu.	9, 25,  57
Date not imprinted on images even when Date stamp is enabled.	<ul style="list-style-type: none"> • The current shooting mode does not support Date stamp. • The date cannot be imprinted on movies. 	 62
Screen for setting time zone and date is displayed when camera is turned on.	The clock battery is exhausted; all settings were restored to their default values.	9, 12
Camera settings reset.		
Camera becomes hot.	The camera may become hot when used for an extended period of time to shoot movies or when used in a hot environment; this is not a malfunction.	–
Camera makes sound.	When Autofocus mode in the movie menu is set to Full-time AF or while in some shooting modes, the camera may produce an audible focusing sound.	25,  56



Shooting Issues



Problem	Cause/Solution	
Cannot switch to shooting mode.	Disconnect the USB cable.	27, 30,  32
No image captured when the shutter-release button is pressed.	<ul style="list-style-type: none"> • When the camera is in playback mode, press the  button or the shutter-release button. • When menus are displayed, press the MENU button. • The batteries are exhausted. • When the flash lamp is flashing, the flash is charging. 	1, 17 2 11 2,  13
Camera cannot focus.	<ul style="list-style-type: none"> • The subject is too close. Try shooting using scene auto selector mode, Close-up scene mode, or macro mode. • The subject is hard to focus on. • Turn the camera off and then on again. 	20, 21,  3,  5,  15  21 9
Images are blurred.	<ul style="list-style-type: none"> • Use the flash. • Increase the ISO sensitivity value. • Enable Electronic VR in the setup menu. • Use a tripod to stabilize the camera when shooting (using the self-timer at the same time is more effective). 	20,  11  47 25,  63 20,  14
Streaks of light or partial discoloration are visible in the monitor.	Smear may occur when extremely bright light strikes the image sensor. When recording movies, avoiding bright objects, such as the sun, reflections of the sun, and electric lights is recommended.	 3

Problem	Cause/Solution	
Bright specks appear in images captured with flash.	The flash is reflecting off particles in the air. Set the flash mode setting to  (off).	20,  12
Flash does not fire.	<ul style="list-style-type: none"> The flash mode is set to  (off). A scene mode that restricts the flash is selected. On is selected for Blink proof in the smart portrait menu. A function that restricts the flash is enabled. 	20,  11,  12  17 25,  49  19
Digital zoom cannot be used.	Digital zoom cannot be used in the following situations. <ul style="list-style-type: none"> When Portrait, Night portrait, or Pet portrait is selected in scene mode When smart portrait mode is selected 	21,  4 21,  8
No sound when shutter is released.	<ul style="list-style-type: none"> Off is selected for Sound settings > Shutter sound in the setup menu. No sound is produced with some shooting modes and settings, even when On is selected. Do not block the speaker. 	25,  64 2
Images appear smeared.	The lens is dirty. Clean the lens.	 7
Colors are unnatural.	White balance or hue is not adjusted properly.	25,  5,  44
Randomly spaced bright pixels ("noise") appear in image.	The subject is dark and the shutter speed is too slow, or ISO sensitivity is too high. Noise can be reduced by: <ul style="list-style-type: none"> Using the flash Specifying a lower ISO sensitivity setting 	 11  47

Problem	Cause/Solution	
Images are too dark (underexposed).	<ul style="list-style-type: none"> The flash mode is set to  (off). The flash window is blocked. The subject is beyond the range of the flash. Adjust exposure compensation. Increase ISO sensitivity. The subject is backlit. Select Backlighting scene mode or set the flash mode setting to  (fill flash). 	20,  11,  17, 13,  16, 20,  16,  47, 20, 21,  6,  11
Images are too bright (overexposed).	Adjust exposure compensation.	20,  16
Unexpected results when flash set to  (auto with red-eye reduction).	When taking images with  (auto with red-eye reduction), or when taking images using fill flash with slow sync and red-eye reduction in Night portrait (either in scene auto selector mode or in scene mode), In-Camera Red Eye Fix may be applied to areas not affected by red-eye in rare cases. Use auto mode or any scene mode other than Night portrait , and change the flash mode to any setting other than  (auto with red-eye reduction) and try taking an image again.	20, 21,  5,  11
Skin tones are not softened.	<ul style="list-style-type: none"> In some shooting conditions, facial skin tones may not be softened. For images containing four or more faces, try using the Skin softening effect in the playback menu. 	 21, 25,  28
Saving images takes time.	It may take more time to save images in the following situations. <ul style="list-style-type: none"> When the noise reduction function is in operation, such as when shooting in a dark environment When the flash mode is set to  (auto with red-eye reduction) When the skin softening function is applied while shooting 	–, 20,  13,  21

Playback Issues

Problem	Cause/Solution	
File cannot be played back.	<ul style="list-style-type: none"> • This camera may not be able to play back images saved with another make or model of digital camera. • This camera cannot play back movies recorded with another make or model of digital camera. • This camera may not be able to play back data edited on a computer. 	–
Cannot zoom in on image.	<ul style="list-style-type: none"> • Playback zoom cannot be used with movies, small pictures, or images that have been cropped to a size of 320 × 240 or smaller. • This camera may not be able to zoom in on images captured with another make or model of digital camera. 	–
Cannot edit image.	<ul style="list-style-type: none"> • Some images cannot be edited. Images that have already been edited may not be edited again. • There is not enough free space in the internal memory or on the memory card. • This camera is unable to edit images captured with other cameras. • Editing functions used for images are not available for movies. 	 25 – – –
Cannot rotate image.	This camera cannot rotate images captured with another make or model of digital camera.	–
Images are not displayed on TV.	<ul style="list-style-type: none"> • Video mode is not correctly set in the setup menu. • The memory card contains no images. Replace the memory card. Remove the memory card to play back images from the internal memory. 	25,  65 6
Nikon Transfer 2 does not start when camera is connected to a computer.	<ul style="list-style-type: none"> • The camera is off. • The batteries are exhausted. • The USB cable is not correctly connected. • The camera is not recognized by the computer. • The computer is not set to start Nikon Transfer 2 automatically. For more information about Nikon Transfer 2, refer to help information contained in ViewNX-i. 	9 11 27, 30 – –

Problem	Cause/Solution	
Images to be printed are not displayed.	<ul style="list-style-type: none"> • The memory card contains no images. Replace the memory card. • Remove the memory card to print images from the internal memory. 	6 8
Cannot select paper size with camera.	<p>The camera cannot be used to select the paper size in the following situations, even when printing from a PictBridge-compatible printer. Use the printer to select the paper size.</p> <ul style="list-style-type: none"> • The printer does not support the paper sizes specified by the camera. • The printer automatically selects the paper size. 	27,  34,  35 –

Specifications

Nikon COOLPIX A10 Digital Camera

Type	Compact digital camera
Number of effective pixels	16.1 million (Image processing may reduce the number of effective pixels.)
Image sensor	$\frac{1}{2}$ -in. type CCD; approx. 16.44 million total pixels
Lens	NIKKOR lens with 5 \times optical zoom
Focal length	4.6–23.0 mm (angle of view equivalent to that of 26–130 mm lens in 35mm [135] format)
f/-number	f/3.2–6.5
Construction	6 elements in 5 groups
Digital zoom magnification	Up to 4 \times (angle of view equivalent to that of approx. 520 mm lens in 35mm [135] format)
Vibration reduction	Electronic VR (movies)
Motion blur reduction	Electronic VR (still pictures)
Autofocus (AF)	Contrast-detect AF
Focus range	<ul style="list-style-type: none">• [W]: Approx. 50 cm (1 ft 8 in.)–∞, [T]: Approx. 80 cm (2 ft 8 in.)–∞• Macro mode: Approx. 10 cm (4 in.) (wide-angle position relative to –∞) (All distances measured from center of front surface of lens)
Focus-area selection	Center, face detection
Monitor	6.7 cm (2.7-in.), approx. 230k-dot, TFT LCD with 5-level brightness adjustment
Frame coverage (shooting mode)	Approx. 98% horizontal and 98% vertical (compared to actual picture)
Frame coverage (playback mode)	Approx. 100% horizontal and 100% vertical (compared to actual picture)

Storage	
Media	Internal memory (approx. 17 MB), SD/SDHC/SDXC memory card (128 GB or less)
File system	DCF and Exif 2.3 compliant
File formats	Still pictures: JPEG Movies: AVI (Video: Motion-JPEG compliant, Audio: PCM monaural)
Image size (pixels)	<ul style="list-style-type: none"> • 16M (High) [4608 × 3456★] • 16M [4608 × 3456] • 8M [3264 × 2448] • 4M [2272 × 1704] • 2M [1600 × 1200] • VGA [640 × 480] • 16:9 [4608 × 2592]
ISO sensitivity (Standard output sensitivity)	ISO 80–1600
Exposure	
Metering mode	Matrix, center-weighted (digital zoom less than 2×), spot (digital zoom 2× or more)
Exposure control	Programmed auto exposure and exposure compensation (–2.0 – +2.0 EV in steps of $\frac{1}{3}$ EV)
Shutter	
Speed	<ul style="list-style-type: none"> • $\frac{1}{2000}$–1 s • 4 s (Fireworks show scene mode)
Aperture	
Range	Electronically-controlled ND filter (–2.7 AV) selection 2 steps (f/3.2 and f/8 [W])
Self-timer	Approx. 10 s
Flash	
Range (approx.) (ISO sensitivity: Auto)	[W]: 0.5–3.6 m (1 ft 8 in.–11 ft) [T]: 0.8–1.7 m (2 ft 8 in.–5 ft 6 in.)
Flash control	TTL auto flash with monitor preflashes

Interface	
USB connector	<p>Hi-Speed USB</p> <ul style="list-style-type: none"> • Supports Direct Print (PictBridge) • Also used as audio/video output connector (NTSC or PAL can be selected for video output.)
Supported languages	
	<p>Arabic, Bengali, Bulgarian, Chinese (Simplified and Traditional), Czech, Danish, Dutch, English, Finnish, French, German, Greek, Hindi, Hungarian, Indonesian, Italian, Japanese, Korean, Marathi, Norwegian, Persian, Polish, Portuguese (European and Brazilian), Romanian, Russian, Serbian, Spanish, Swedish, Tamil, Telugu, Thai, Turkish, Ukrainian, Vietnamese</p>
Power sources	
	<ul style="list-style-type: none"> • Two LR6/L40 (AA-size) alkaline batteries • Two FR6/L91 (AA-size) lithium batteries • Two EN-MH2 rechargeable Ni-MH batteries (available separately) • AC Adapter EH-65A (available separately)
Battery life¹	
Still pictures	<ul style="list-style-type: none"> • Approx. 200 shots when using alkaline batteries • Approx. 730 shots when using lithium batteries • Approx. 500 shots when using EN-MH2 batteries
Movies (actual battery life for recording) ²	<ul style="list-style-type: none"> • Approx. 1 h 25 min when using alkaline batteries • Approx. 4 h 15 min when using lithium batteries • Approx. 2 h 40 min when using EN-MH2 batteries
Tripod socket	
	1/4 (ISO 1222)
Dimensions (W × H × D)	
	Approx. 96.4 × 59.4 × 28.9 mm (3.8 × 2.4 × 1.2 in.) (excluding projections)
Weight	
	Approx. 160 g (5.7 oz) (including batteries and SD memory card)
Operating environment	
Temperature	0°C–40°C (32°F–104°F)
Humidity	85% or less (no condensation)

- Unless otherwise stated, all figures assume fresh LR6/L40 (AA-size) alkaline batteries and an ambient temperature of $23 \pm 3^{\circ}\text{C}$ ($73.4 \pm 5.4^{\circ}\text{F}$) as specified by the Camera and Imaging Products Association (CIPA).
- ¹ Battery life may vary depending on conditions of use, such as the interval between shots or the length of time that menus and images are displayed.
The included batteries are for trial use only. Figures listed for lithium batteries are measured using commercially available FR6/L91 (AA-size) Energizer(R) Ultimate Lithium batteries.
 - ² Individual movie files cannot exceed 4 GB in size or 29 minutes in length. Recording may end before this limit is reached if camera temperature becomes elevated.

Specifications

- Nikon will not be held liable for any errors this manual may contain.
- The appearance of this product and its specifications are subject to change without notice.

Applicable Memory Cards

The camera supports SD, SDHC, and SDXC memory cards (128 GB or less).

- Memory cards with an SD Speed Class rating of 6 or faster are recommended for recording movies. When using a slower memory card, movie recording may stop unexpectedly.
- If you use a card reader, make sure that it is compatible with your memory card.
- Contact the manufacturer for details on memory card features, operation, and performance guarantees.

Trademark Information

- Windows is either a registered trademark or trademark of Microsoft Corporation in the United States and/or other countries.
- Mac is a trademark or registered trademark of Apple Inc. in the U.S. and other countries.
- Adobe, the Adobe logo, and Reader are either trademarks or registered trademarks of Adobe Systems Incorporated in the United States and/or other countries.
- SDXC, SDHC and SD Logos are trademarks of SD-3C, LLC.



- PictBridge is a trademark.
- All other trade names mentioned in this manual or the other documentation provided with your Nikon product are trademarks or registered trademarks of their respective holders.

FreeType License (FreeType2)

- Portions of this software are copyright © 2012 The FreeType Project (<http://www.freetype.org>). All rights reserved.

MIT License (HarfBuzz)

- Portions of this software are copyright © 2016 The HarfBuzz Project (<http://www.freedesktop.org/wiki/Software/HarfBuzz>). All rights reserved.

Index

Symbols

T Telephoto 15

W Wide-angle 15

Playback zoom 17, 23

Thumbnail playback 17, 24

Scene auto selector mode 21, 3

Scene mode 21, 4

SE Special effects mode 21, 7

Smart portrait mode 21, 8

Auto mode 21, 10

Playback mode 17

Setup menu 25, 57

Apply selection button 2

Shooting mode button 2

Movie-record button 2

Playback button 2, 17

Delete button 2, 18

MENU button 2, 25

Flash mode 20, 11

Self-timer 20, 14

Macro mode 20, 15

Exposure compensation 20, 16

Help 4

A

AC adapter 72

Aperture value 15

Audio/video cable 28, 31, 72

Audio/video-in jack 28, 31

Auto flash 12

Auto mode 21, 10

Auto off 12, 64

Autofocus 21, 56

Autofocus mode 56

B

Backlighting 4, 6

Battery 6, 12

Battery charger 72

Battery level indicator 11

Battery type 66

Battery-chamber/memory card slot cover
..... 2, 6

Beach 4

Blink proof 49

Brightness 60

Button sound 64

C

Calendar display 24

Close-up 4, 5

Computer 28, 30

Connector cover 2









Continuous shooting 46

Copy 54







Crop 23, 30

Cyanotype **CO** 7













D









Date and time	9, 	57
Date format.....	10, 	57
Date stamp.....		62
Daylight saving time	10, 	59
Delete.....		18
Digital zoom.....		15
Direct print.....	28, 	32
D-Lighting		27
Dusk/dawn 		4

E

Electronic VR.....		63	
EN-MH1.....		4	
EN-MH2.....		72, 	4
Exposure compensation.....	20, 	16	
Extension.....		71	
Eyelet for camera strap.....		1	

F

Face detection.....		20	
File name.....		71	
Fill flash.....		12	
Fireworks show 		4, 	6
Firmware version.....		67	
Flash	1, 	11	
Flash lamp	2, 	13	
Flash mode	20, 	11	
Flash off.....		12	
Focus.....	14, 	20	
Focus area.....		14	
Focus indicator.....		4	

Focus lock.....		22	
Food 		4, 	5
Format internal memory		65	
Format memory cards.....	7, 	65	
Formatting	7, 	65	
Full-frame playback		17	
Full-time AF.....		56	

H

Help		4
High-contrast monochrome 		7









I

Image mode.....		42
Internal memory.....		8
ISO sensitivity.....		47

L

Landscape 		4
Language		65
Lens.....	1, 	15
Lens cover.....		1

M

Macro mode.....	20, 	15
Memory card.....	6, 	19
Memory card slot.....		6
Microphone.....		1
Mirror 		7
Monitor.....	2, 3, 	7
Monitor settings.....		60
Movie length.....	23, 	37
Movie menu	25, 	55
Movie options		55

Movie playback 23, 39
Movie recording 23, 37
Movie-record button 2
Multi selector 2

N

Night landscape 4
Night portrait 4, 5
Nikon Transfer 2 32
Nostalgic sepia **SE** 7
Number of exposures remaining
..... 11, 43

O

Optical zoom 15
Optional accessories 72

P

Paper size 34, 35
Party/indoor 4, 5
Pet portrait auto release 6
Pet portrait 4, 6
Photo info 60
PictBridge 28, 32
Playback 17, 39
Playback button 2, 17
Playback menu 25, 50
Playback mode 17
Playback zoom 17, 23
Pop **POP** 7
Portrait 4
Power 9
Power switch/power-on lamp 1, 9

Preset manual 45
Pressing halfway 15
Print 28, 33, 35
Printer 28, 32
Protect 51

Q















Quick effects 26

R







Rechargeable battery 72
Recording movies 23, 37
Red-eye reduction 12, 13
Reset all 66
Rotate image 53

S





Scene auto selector mode 21, 3
Scene mode 21, 4
Selective color 7
Self-timer 20, 14
Self-timer lamp 1, 14
Setup menu 25, 57
Shooting 13
Shooting menu 25, 41, 42
Shooting mode button 2
Shutter sound 64
Shutter speed 15
Shutter-release button 1, 14
Single AF 56
Single-frame shooting 46
Skin softening 28, 48
Slide show 50

Slow sync		12
Small picture		29
Smart portrait menu.....	 41, 	48
Smart portrait mode		21, 
Smile timer.....		48
Snow 		4
Sound settings.....		64
Speaker.....		2
Special effects mode.....		21, 
Sports 	 4, 	5
Strap		ii
Sunset 		4

I

Thumbnail playback.....		17, 
Time difference		58
Time zone		10, 
Time zone and date.....		9, 
Tripod socket.....		2, 
TV		28, 

U

USB cable		27, 30,  32, 
USB/audio/video output connector		2, 27, 30,  31, 

V

Video mode		65
ViewNX-i		29
Volume		39

W

White balance		44
---------------------	---	----

Z

Zoom		15
Zoom control.....		1, 15
Zoom in.....		15
Zoom out		15

No reproduction in any form of this manual, in whole or in part (except for brief quotation in critical articles or reviews), may be made without written authorization from NIKON CORPORATION.

NIKON CORPORATION

© 2016 Nikon Corporation



CT5J01(11)
6MN64411-01