

**SAMSUNG**

SM-G930F  
SM-G930FD

# User Manual

# Table of Contents

## Basics

- 4 Read me first
- 6 Package contents
- 7 Device layout
- 9 Battery
- 15 SIM or USIM card (nano-SIM card)
- 21 Memory card (microSD card)
- 24 USB connector
- 25 Turning the device on and off
- 25 Touchscreen
- 28 Home screen
- 34 Lock screen
- 36 Notification panel
- 38 Entering text
- 41 Screen capture
- 42 Opening apps
- 42 Multi window
- 46 Samsung account
- 48 Transferring data from your previous device
- 51 Device and data management
- 53 Quick connect
- 57 Sharing features
- 58 Emergency mode

## Applications

- 59 Installing or uninstalling apps
- 61 Phone
- 65 Contacts
- 68 Messages
- 71 Internet
- 73 Email
- 74 Camera
- 95 Gallery
- 98 Samsung Pay
- 101 Samsung Gear
- 102 Game Launcher
- 105 S Planner
- 106 S Health
- 109 S Voice
- 111 Voice Recorder
- 113 My Files
- 113 Memo
- 114 Clock
- 115 Calculator
- 116 Google apps

## Settings

- 118 Introduction
- 118 Wi-Fi
- 120 Bluetooth
- 122 Flight mode
- 122 Mobile hotspot and tethering
- 123 Data usage
- 124 SIM card manager (dual SIM models)
- 125 Mobile networks
- 125 NFC and payment
- 128 More connection settings
- 130 Smart Manager
- 132 Applications
- 133 Sounds and vibration
- 134 Notifications
- 134 Do not disturb
- 135 Display
- 136 Advanced features
- 137 Wallpaper
- 138 Themes
- 138 Home screen
- 138 Lock screen and security
- 143 Privacy and safety
- 147 Easy mode
- 147 Accessibility
- 148 Accounts
- 148 Backup and reset
- 149 Language and input
- 150 Battery
- 150 Storage
- 151 Date and time
- 151 User manual
- 151 About device

## Appendix

- 152 Accessibility
- 167 Troubleshooting
- 173 Removing the battery

# Basics

## Read me first

Please read this manual before using the device to ensure safe and proper use.

- Descriptions are based on the device's default settings.
- Some content may differ from your device depending on the region, service provider, model specifications, or device's software.
- Content (high quality content) that requires high CPU and RAM usage will affect the overall performance of the device. Apps related to the content may not work properly depending on the device's specifications and the environment that it is used in.
- Samsung is not liable for performance issues caused by apps supplied by providers other than Samsung.
- Samsung is not liable for performance issues or incompatibilities caused by edited registry settings or modified operating system software. Attempting to customise the operating system may cause the device or apps to work improperly.
- Software, sound sources, wallpapers, images, and other media provided with this device are licensed for limited use. Extracting and using these materials for commercial or other purposes is an infringement of copyright laws. Users are entirely responsible for illegal use of media.
- You may incur additional charges for data services, such as messaging, uploading and downloading, auto-syncing, or using location services depending on your data plan. For large data transfers, it is recommended to use the Wi-Fi feature.
- Default apps that come with the device are subject to updates and may no longer be supported without prior notice. If you have questions about an app provided with the device, contact a Samsung Service Centre. For user-installed apps, contact service providers.
- Modifying the device's operating system or installing softwares from unofficial sources may result in device malfunctions and data corruption or loss. These actions are violations of your Samsung licence agreement and will void your warranty.

- Depending on the region or model, some devices are required to receive approval from the Federal Communications Commission (FCC). If your device is approved by the FCC, you can view the FCC ID of the device. To view the FCC ID, tap **Apps** → **Settings** → **About device** → **Battery info**.
- Depending on the region, you can view the regulatory information on the device. To view the information, tap **Apps** → **Settings** → **About device** → **Regulatory information**.

## Maintaining water and dust resistance

Your device supports water- and dust-resistance. Follow these tips carefully to maintain the water- and dust-resistance of your device. Failure to do so may result in damage to your device.

- Do not immerse the device in water deeper than 1.5 m and keep it submerged for more than 30 minutes.
- Do not expose the device to **water moving with force**, such as running water from taps, ocean waves, or waterfalls.
- If the device is exposed to clean water, dry it thoroughly with a clean, soft cloth. If the device is exposed to other liquids, rinse it with clean water and dry it thoroughly with a clean, soft cloth. If you do not follow these instructions, the device's performance and appearance may be affected.
- **If the device has been immersed in water or the microphone, speaker, or receiver is wet**, sound may not be heard clearly during a call. Wipe the device with a dry cloth or dry it thoroughly before using it.
- The touchscreen and other features may not work properly **if the device is used in water**.
- **Your device has been tested in a controlled environment and certified to be water- and dust-resistant in specific situations (meets requirements of classification IP68 as described by the international standard IEC 60529-Degrees of Protection provided by Enclosures [IP Code]; test conditions: 15-35°C, 86-106 kPa, 1.5 metre, 30 minutes). Despite this classification, it is still possible for your device to be damaged in certain situations.**

## Instructional icons



**Warning:** situations that could cause injury to yourself or others



**Caution:** situations that could cause damage to your device or other equipment



**Notice:** notes, usage tips, or additional information

## Package contents

Check the product box for the following items:

- Device
- Quick start guide



- The items supplied with the device and any available accessories may vary depending on the region or service provider.
- The supplied items are designed only for this device and may not be compatible with other devices.
- Appearances and specifications are subject to change without prior notice.
- You can purchase additional accessories from your local Samsung retailer. Make sure they are compatible with the device before purchase.
- Use only Samsung-approved accessories. Using unapproved accessories may cause the performance problems and malfunctions that are not covered by the warranty.
- Availability of all accessories is subject to change depending entirely on manufacturing companies. For more information about available accessories, refer to the Samsung website.

# Device layout

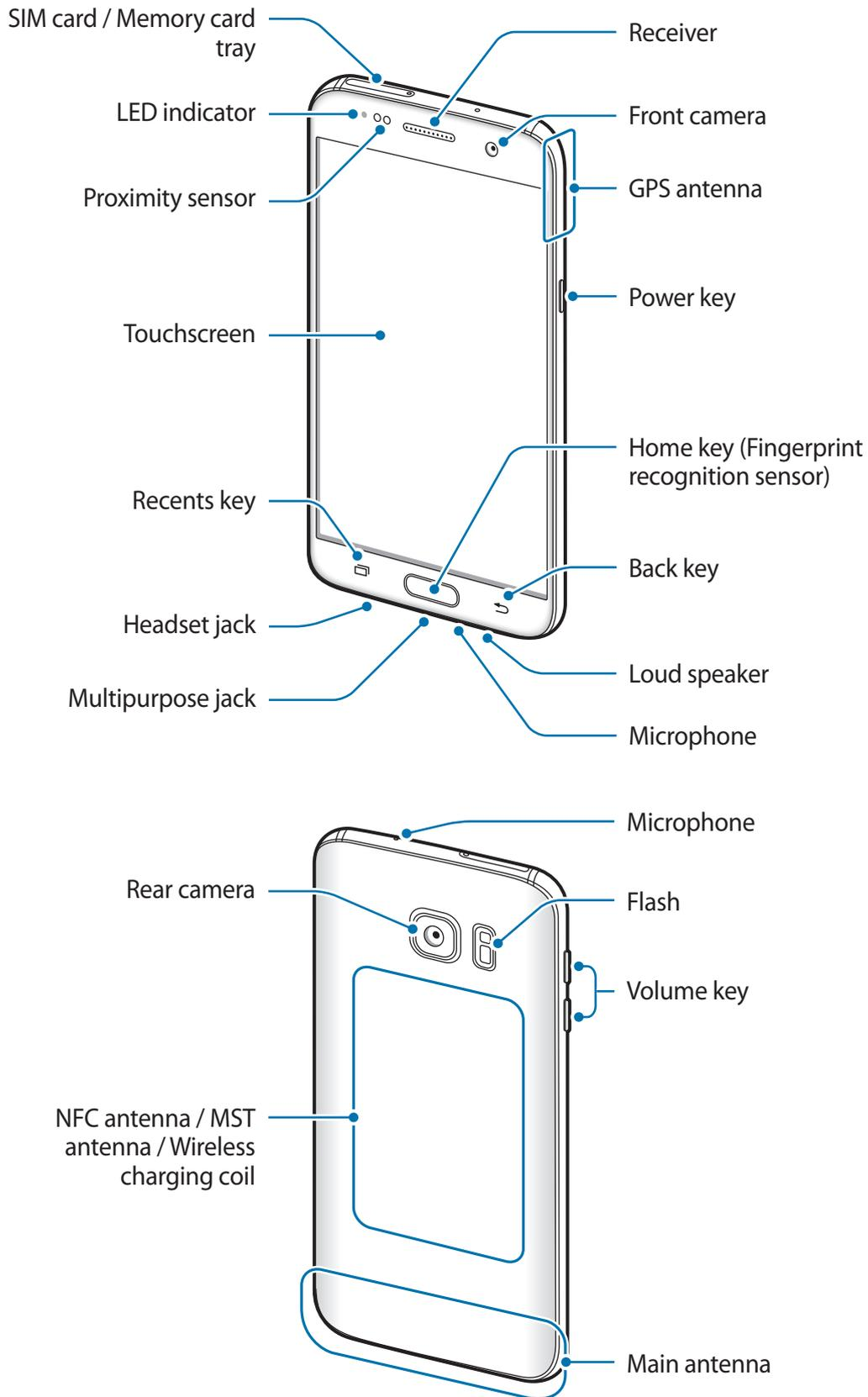



- Connectivity problems and battery drain may occur in the following situations:
  - If you attach metallic stickers on the antenna area of the device
  - If you attach a device cover made with metallic material to the device
  - If you cover the device's antenna area with your hands or other objects while using certain features, such as calls or the mobile data connection
- Using a Samsung-approved screen protector is recommended. Unapproved screen protectors may cause the sensors to malfunction.

## Keys

Key	Function
 <b>Power</b>	<ul style="list-style-type: none"> <li>• Press and hold to turn the device on or off.</li> <li>• Press to turn on or lock the screen.</li> </ul>
 <b>Recents</b>	<ul style="list-style-type: none"> <li>• Tap to open the list of recent apps.</li> <li>• Tap and hold to launch the split screen view.</li> </ul>
 <b>Home</b>	<ul style="list-style-type: none"> <li>• Press to turn on the screen while the screen is locked.</li> <li>• Press to return to the Home screen.</li> <li>• Press and hold to launch <b>Google</b>.</li> </ul>
 <b>Back</b>	<ul style="list-style-type: none"> <li>• Tap to return to the previous screen.</li> <li>• Tap and hold to access additional options for the current screen.</li> </ul>
 <b>Volume</b>	<ul style="list-style-type: none"> <li>• Press to adjust the device volume.</li> </ul>

# Battery

## Charging the battery

Charge the battery before using it for the first time or when it has been unused for extended periods.



Use only Samsung-approved chargers, batteries, and cables. Unapproved chargers or cables can cause the battery to explode or damage the device.

- 1 Connect the USB cable to the USB power adaptor, and then plug the end of the USB cable into the multipurpose jack.

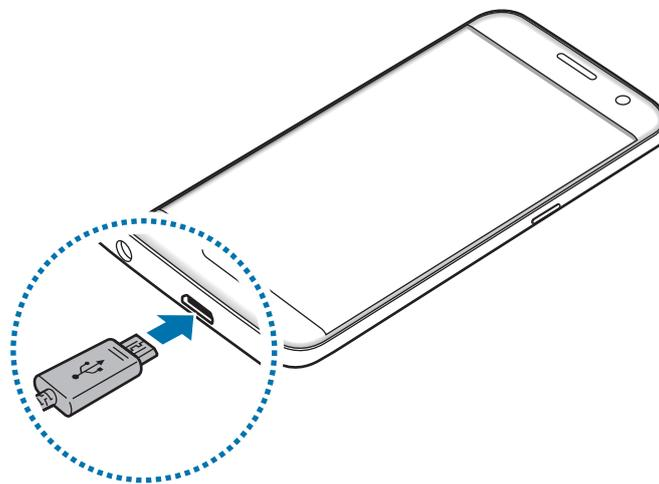

Connecting the charger improperly may cause serious damage to the device. Any damage caused by misuse is not covered by the warranty.

- 2 Plug the USB power adaptor into an electric socket.

3 After fully charging, disconnect the device from the charger. First unplug the charger from the device, and then unplug it from the electric socket.



To save energy, unplug the charger when not in use. The charger does not have a power switch, so you must unplug the charger from the electric socket when not in use to avoid wasting power. The charger should remain close to the electric socket and easily accessible while charging.

## Viewing the remaining charging time

While charging, open the Home screen and tap **Apps** → **Settings** → **Battery**.



The actual charging time may vary depending on the status of your device and the charging conditions. The remaining charging time may not be displayed when you charge the device in very cold or very hot conditions.

## Reducing the battery consumption

Your device provides various options that help you conserve battery power.

- Optimise the device using the Smart manager.
- When you are not using the device, switch to sleep mode by pressing the Power key.
- Activate power saving mode.
- Close unnecessary apps.
- Deactivate the Bluetooth feature when not in use.
- Deactivate the Wi-Fi feature when not in use.
- Deactivate auto-syncing of apps that need to be synced, such as emails.
- Decrease the backlight time.
- Decrease the screen brightness.

## Battery charging tips and precautions

- When the battery power is low, the battery icon appears empty.
- If the battery is completely discharged, the device cannot be turned on immediately when the charger is connected. Allow a depleted battery to charge for a few minutes before turning on the device.
- If you use multiple apps at once, network apps, or apps that need a connection to another device, the battery will drain quickly. To avoid losing power during a data transfer, always use these apps after fully charging the battery.
- Using a power source other than the charger, such as a computer, may result in a slower charging speed due to a lower electric current.
- The device can be used while it is charging, but it may take longer to fully charge the battery.
- If the device receives an unstable power supply while charging, the touchscreen may not function. If this happens, unplug the charger from the device.
- While charging, the device and the charger may heat up. This is normal and should not affect the device's lifespan or performance. If the battery gets hotter than usual, the charger may stop charging.
- If you charge the device while the multipurpose jack is wet, the device may be damaged. Thoroughly dry the multipurpose jack before charging the device.
- If the device is not charging properly, take the device and the charger to a Samsung Service Centre.

## Fast charging

The device has a built-in fast charging feature. You can use this feature to charge the battery more quickly while the device or its screen is turned off.

### About Fast charging

- Fast charging uses battery charging technology that charges the battery faster by increasing the charging power. The device supports Samsung's Adaptive fast charging feature and Qualcomm Quick Charge 2.0.
- To use Fast charging on your device, connect it to a battery charger that supports Adaptive fast charging or Quick Charge 2.0.

### Increasing the charging speed

To increase the charging speed, turn the device or its screen off when you charge the battery.

- While charging the battery when the device is turned off, the ⚡ icon appears on the screen.
- You cannot use the fast charging feature when the screen is turned on. Turn off the screen to increase the charging speed.

If the fast charging feature is not activated, on the Home screen, tap **Apps** → **Settings** → **Battery**, and then tap the **Fast cable charging** switch to activate it.



- You cannot use the built-in fast charging feature when you charge the battery using a standard battery charger.
- If the device heats up or the ambient air temperature rises, the charging speed may decrease automatically. This is a normal operating condition to prevent damage to the device.

## Wireless charging

The device has a built-in wireless charging coil. You can charge the battery using a wireless charger (sold separately).

### Fast wireless charging

You can charge your device faster using the fast wireless charging feature. To use this feature, you must use a charger and components that support the fast wireless charging feature.



A fan inside the charger may produce noise during fast wireless charging. To reduce the fan noise, you must deactivate the fast wireless charging feature. The on/off option will be added in your device's settings menu when you first place it on the charger. On the Home screen, tap **Apps** → **Settings** → **Battery**, and then tap the **Fast wireless charging** switch to deactivate it. Deactivating this feature will reduce noise, but may result in slower charging times.

### Charging the battery

- 1 Place the centre of the device's back on the centre of the wireless charger.

You can check the remaining charging time on the screen. The actual remaining time may vary depending on the charging conditions.

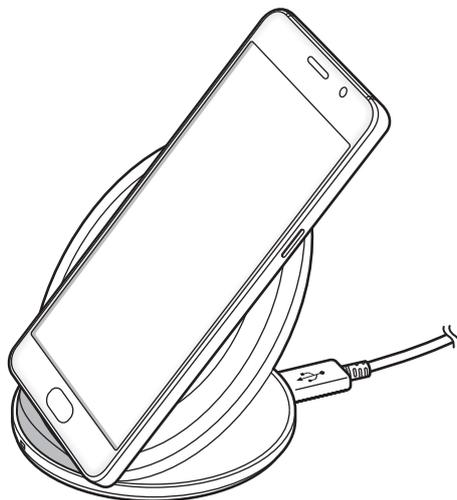

2 After fully charging, disconnect the device from the wireless charger.



- When there are foreign materials between the device and the wireless charger, the device may not charge properly.
- If you use the wireless charger in areas with weak network signals, you may lose network reception.
- Use Samsung-approved wireless chargers. If you use other wireless chargers, the battery may not charge properly.

## Power saving mode

Save the battery power by limiting the device's functions.

On the Home screen, tap **Apps** → **Settings** → **Battery** → **Power saving mode**, and then tap the switch to activate it.

To automatically activate power saving mode when the remaining battery power reaches the preset level, tap **Start power saving** and select an option.

## Ultra power saving mode

Use this mode to extend the device's battery power. In ultra power saving mode, the device performs the following:

- Displays colours on the screen as grey tones.
- Restricts the available apps to essential and selected apps only.
- Deactivates the mobile data connection when the screen turns off.
- Deactivates the Wi-Fi and Bluetooth features.

On the Home screen, tap **Apps** → **Settings** → **Battery** → **Ultra power saving mode**, and then tap the switch to activate it.

To deactivate ultra power saving mode, tap **MORE** → **Disable Ultra power saving mode**.



The usage time left shows the time remaining before the battery power runs out. Usage time left may vary depending on your device settings and operating conditions.

## SIM or USIM card (nano-SIM card)

### Installing the SIM or USIM card

Insert the SIM or USIM card provided by the mobile telephone service provider.



Use caution not to lose or let others use the SIM or USIM card. Samsung is not responsible for any damages or inconveniences caused by lost or stolen cards.



- **Dual SIM models:** In some areas, data transfer speeds may be slower if two SIM cards are inserted in the device than when one SIM card is inserted.
- Some LTE services may not be available depending on the service provider. For more information about service availability, contact your service provider.

#### ► Single SIM models:

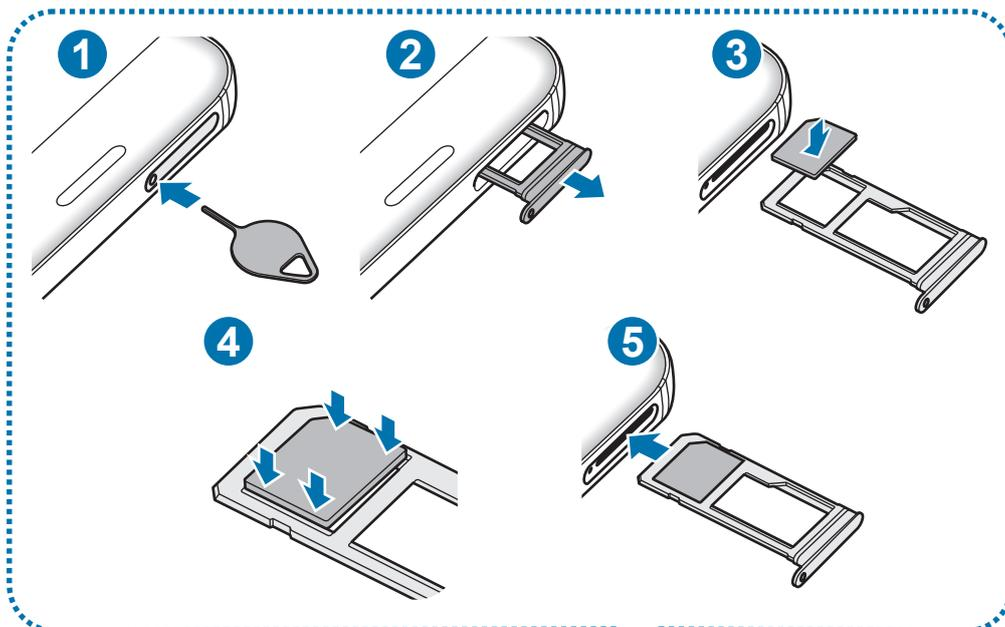

► Dual SIM models:

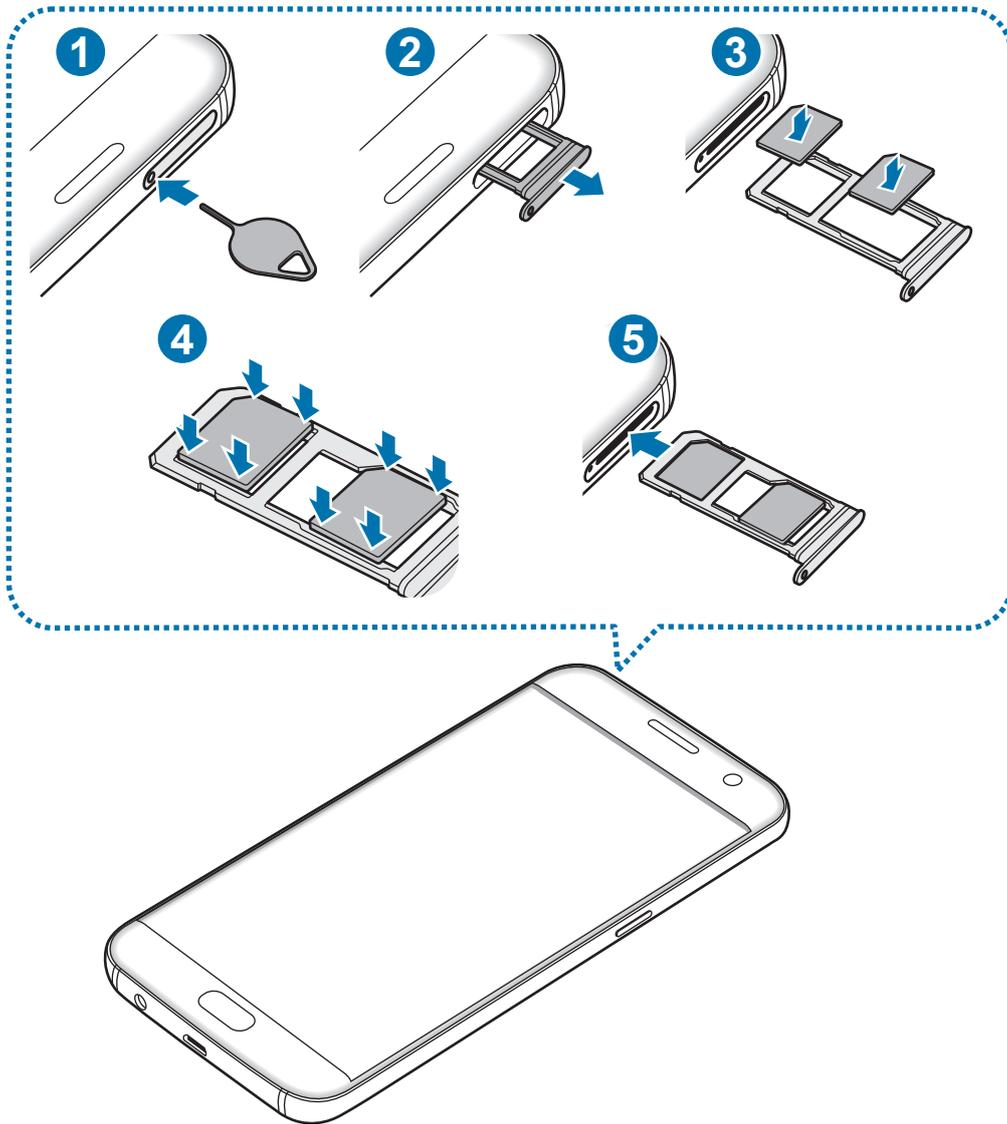

1 Insert the ejection pin into the hole on the tray to loosen the tray.



Ensure that the ejection pin is perpendicular to the hole. Otherwise, the device may be damaged.

2 Pull out the tray gently from the tray slot.

3 ► **Single SIM models:** Place the SIM or USIM card on the tray with the gold-coloured contacts facing downwards.

► **Dual SIM models:** Place the SIM or USIM card on the tray with the gold-coloured contacts facing downwards.

Place the primary SIM or USIM card on the tray 1 (1) and the secondary SIM or USIM card on the tray 2 (2).

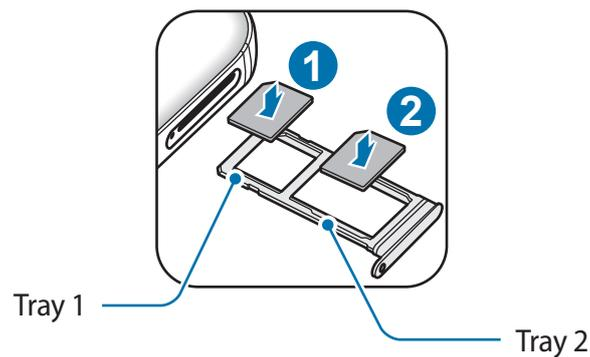

4 Gently press the SIM or USIM card into the tray to secure it.

! If the card is not fixed firmly into the tray, the SIM card may leave or fall out of the tray.

5 Insert the tray back into the tray slot.

- ! • If you insert the tray into your device while the tray is wet, your device may be damaged. Always make sure the tray is dry.
- Fully insert the tray into the tray slot to prevent liquid from entering your device.

## Correct card installation

### ► Single SIM models:

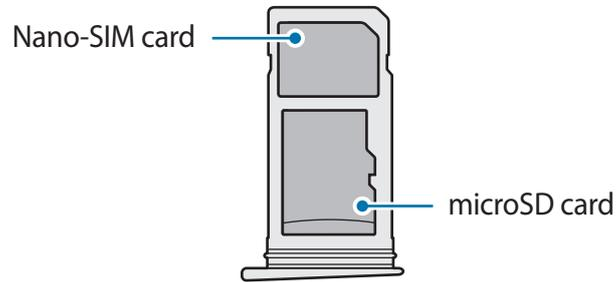

### ► Dual SIM models:

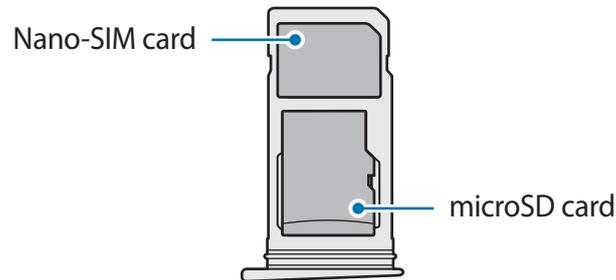
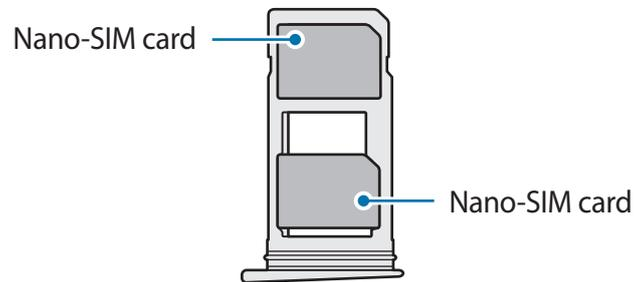

- Use only a nano-SIM card.
- You cannot insert a nano-SIM card and a microSD card in tray 2 at the same time.

## Removing the SIM or USIM card

- 1 Insert the ejection pin into the hole on the tray to loosen the tray.
- 2 Pull out the tray gently from the tray slot.
- 3 Remove the SIM or USIM card.
  - ▶ **Single SIM models:**

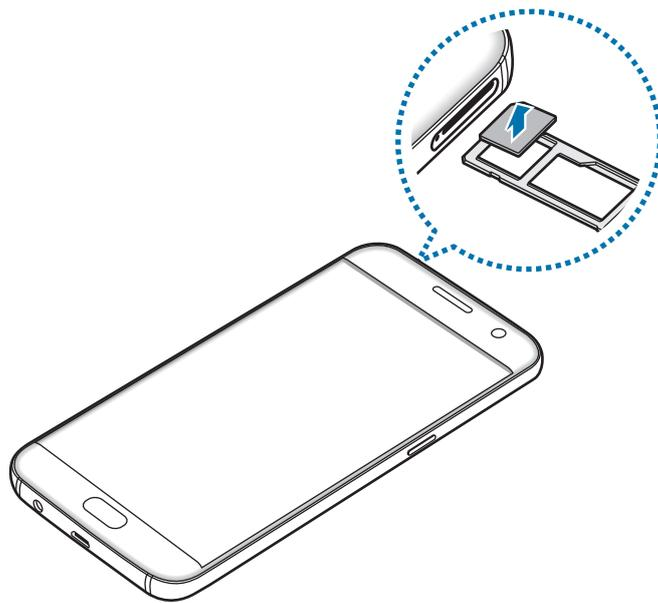

- ▶ **Dual SIM models:**

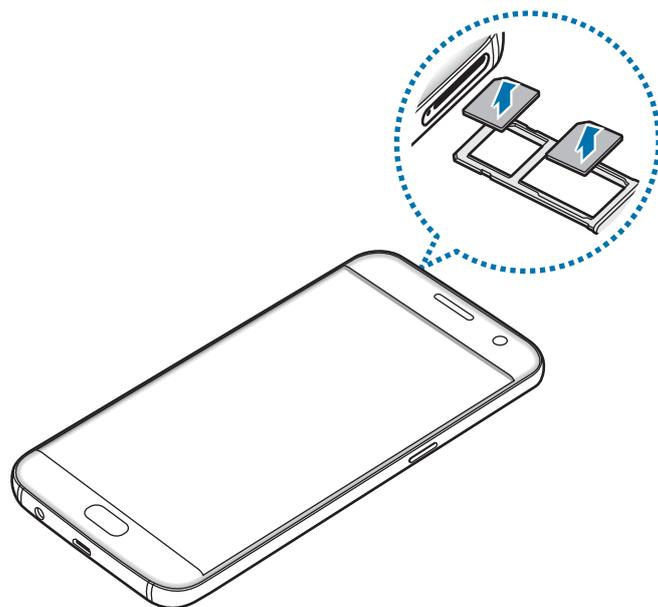

- 4 Insert the tray back into the tray slot.

## Using dual SIM or USIM cards (dual SIM models)

If you insert two SIM or USIM cards, you can have two phone numbers or service providers for a single device.

### Activating SIM or USIM cards

On the Home screen, tap **Apps** → **Settings** → **SIM card manager**. Select a SIM or USIM card and tap the switch to activate it.

### Customising SIM or USIM cards

On the Home screen, tap **Apps** → **Settings** → **SIM card manager** and select a SIM or USIM card to access the following options:

- **Icon:** Change the icon of the SIM or USIM card.
- **Name:** Change the display name of the SIM or USIM card.
- **Network mode:** Select a network type to use with the SIM or USIM card.

### Setting preferred SIM or USIM cards

When two cards are activated, you can assign voice calls, messaging, and data services to specific cards.

On the Home screen, tap **Apps** → **Settings** → **SIM card manager** and set the feature preferences for your cards in **Preferred SIM card**.

## Memory card (microSD card)

### Installing a memory card

Your device accepts memory cards with maximum capacities of 200 GB. Depending on the memory card manufacturer and type, some memory cards may not be compatible with your device.



- Some memory cards may not be fully compatible with the device. Using an incompatible card may damage the device or the memory card, or corrupt the data stored in it.
- Use caution to insert the memory card right-side up.



- The device supports the FAT and the exFAT file systems for memory cards. When inserting a card formatted in a different file system, the device asks to reformat the memory card.
- Frequent writing and erasing of data shortens the lifespan of memory cards.
- When inserting a memory card into the device, the memory card's file directory appears in the **My Files** → **SD card** folder.

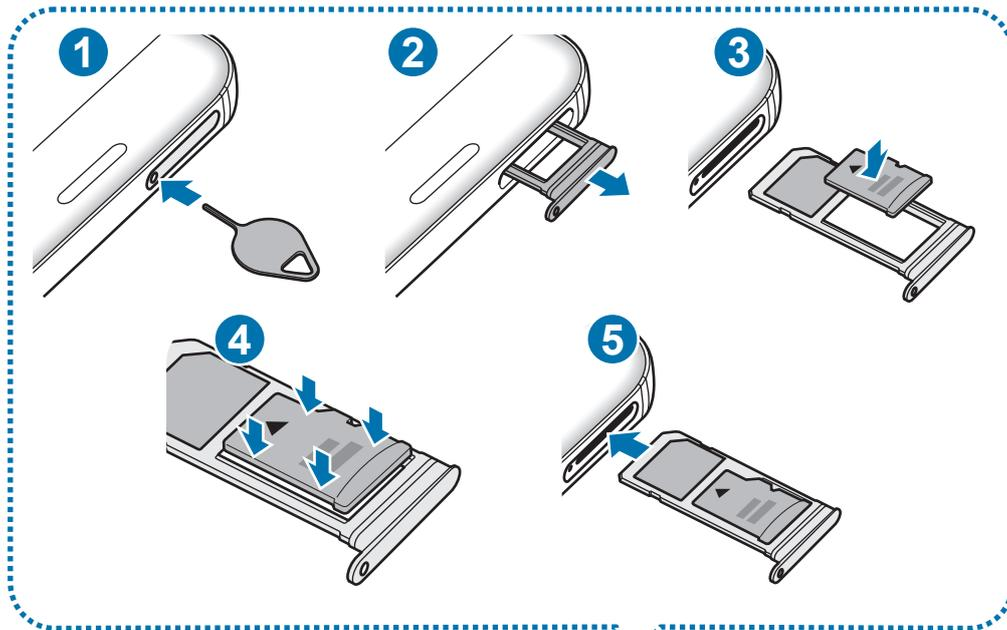

**1** Insert the ejection pin into the hole on the tray to loosen the tray.

 Ensure that the ejection pin is perpendicular to the hole. Otherwise, the device may be damaged.

**2** Pull out the tray gently from the tray slot.

 When you remove the tray from the device, the mobile data connection will be disabled.

- 3 Place a memory card on the tray 2 with the gold-coloured contacts facing downwards.

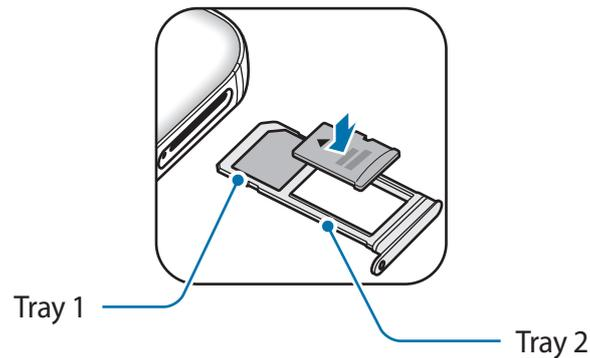

- 4 Gently press the memory card into the tray to secure it.

- 5 Insert the tray back into the tray slot.

-  If you insert the tray into your device while the tray is wet, your device may be damaged. Always make sure the tray is dry.
- Fully insert the tray into the tray slot to prevent liquid from entering your device.

## Removing the memory card

Before removing the memory card, first unmount it for safe removal.

On the Home screen, tap **Apps** → **Settings** → **Storage** → **SD card** → **Unmount**.

- 1 Insert the ejection pin into the hole on the tray to loosen the tray.

- 2 Pull out the tray gently from the tray slot.

- 3 Remove the memory card.

- 4 Insert the tray back into the tray slot.

-  Do not remove the memory card while the device is transferring or accessing information. Doing so can cause data to be lost or corrupted or damage to the memory card or device. Samsung is not responsible for losses that result from the misuse of damaged memory cards, including the loss of data.

## Formatting the memory card

A memory card formatted on a computer may not be compatible with the device. Format the memory card on the device.

On the Home screen, tap **Apps** → **Settings** → **Storage** → **SD card** → **Format** → **FORMAT**.



Before formatting the memory card, remember to make backup copies of all important data stored in the memory card. The manufacturer's warranty does not cover loss of data resulting from user actions.

## USB connector

With the supplied USB connector (On-The-Go Adaptor), you can transfer data from other mobile devices or connect USB peripheral devices, such as a mouse and keyboard, to your device.

### Transferring data from your previous device

You can connect your previous device to your device with the USB connector and a USB cable to easily and quickly transfer data without installing an app in the previous device. Refer to [Transferring data via a USB connection](#) for more information.

### Connecting a USB peripheral device

Plug the USB connector into the multipurpose jack of your device and connect the USB peripheral device to the USB connector.



Some USB peripheral devices may not be compatible with your device.

## Turning the device on and off

Press and hold the Power key for a few seconds to turn on the device.

When you turn on your device for the first time or after performing a data reset, follow the on-screen instructions to set up your device.

To turn off the device, press and hold the Power key, and then tap **Power off**.



Follow all posted warnings and directions from authorised personnel in areas where the use of wireless devices is restricted, such as aeroplanes and hospitals.

## Restarting the device

If your device is frozen and unresponsive, press and hold the Power key and the Volume Down key simultaneously for more than 7 seconds to restart it.

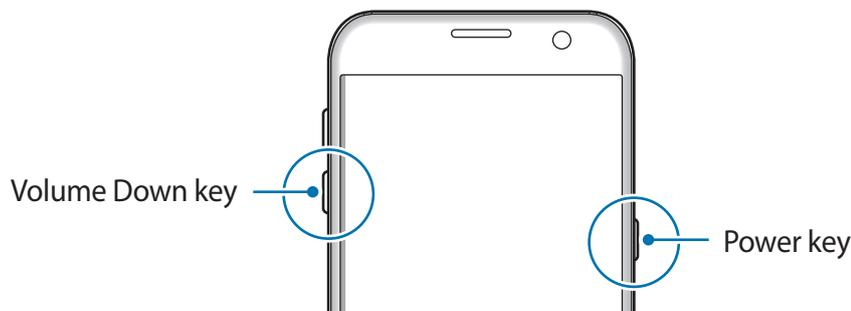

## Touchscreen



- Do not allow the touchscreen to come into contact with other electrical devices. Electrostatic discharges can cause the touchscreen to malfunction.
- To avoid damaging the touchscreen, do not tap it with anything sharp or apply excessive pressure to it with your fingertips.



- The device may not recognise touch inputs close to the edges of the screen, which are outside of the touch input area.
- Leaving the touchscreen idle for extended periods may result in afterimages (screen burn-in) or ghosting. Turn off the touchscreen when you do not use the device.
- It is recommended to use fingers when you use the touchscreen.

## Tapping

To open an app, to select a menu item, to press an on-screen button, or to enter a character using the keyboard on the screen, tap it with your finger.

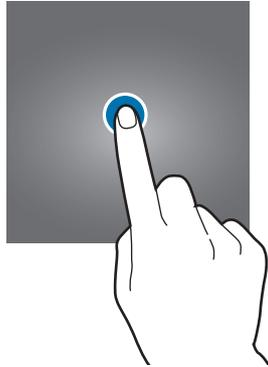

## Tapping and holding

Tap and hold an item or the screen for more than 2 seconds to access available options.

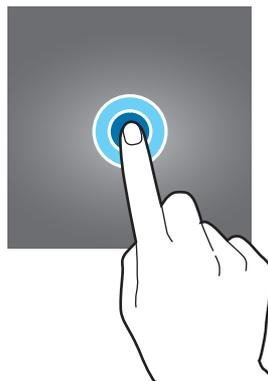

## Dragging

To move an item, tap and hold it and drag it to the target position.

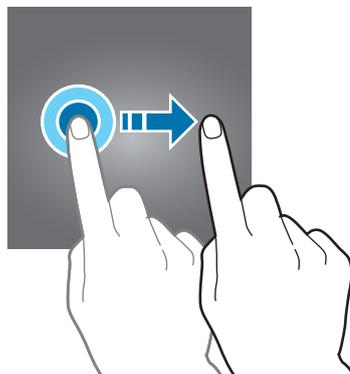

## Double-tapping

Double-tap on a webpage or image to zoom in. Double-tap again to return.

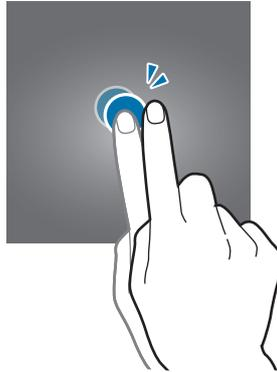

## Swiping

Swipe to the left or right on the Home screen or the Apps screen to view other panels. Swipe upwards or downwards to scroll through a webpage or a list of items, such as contacts.

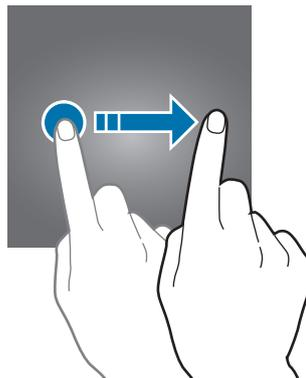

## Spreading and pinching

Spread two fingers apart on a webpage, map, or image to zoom in a part. Pinch to zoom out.

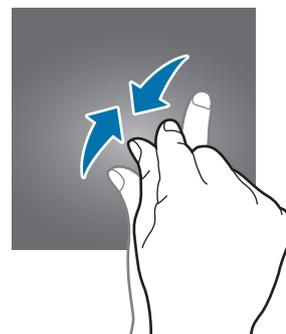
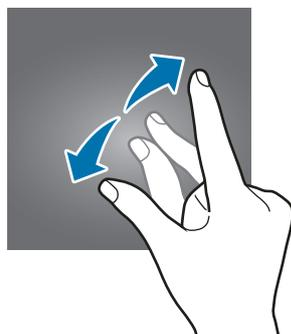

# Home screen

## Home screen

The Home screen is the starting point for accessing all of the device's features. It displays widgets, shortcuts to apps, and more.

To view other panels, swipe to the left or right.



The Home screen may appear differently depending on the region or service provider.



## Home screen options

On the Home screen, tap **Apps** → **Settings** → **Home screen** to access the available options. Alternatively, on the Home screen, tap and hold an empty area. Customise the Home screen by adding, deleting, or rearranging Home screen panels. You can also set the Home screen wallpaper, add widgets to the Home screen, and more.

- **Wallpapers:** Change the wallpaper settings for the Home screen and the locked screen.
- **Widgets:** Add widgets to the Home screen. Widgets are small apps that launch specific app functions to provide information and convenient access on your Home screen.
- **Themes:** Change the device's theme. Visual elements of interface, such as colours, icons, and wallpapers, will change depending on the selected theme.
- **Screen grid:** Change the size of the grid to display more or less items on the Home screen and the Apps screen.



## Adding items

Tap and hold an app or a folder from the Apps screen, and then drag it to the Home screen. To add widgets, tap and hold an empty area on the Home screen, tap **Widgets**, tap and hold a widget, and then drag it to the Home screen.

## Moving items

Tap and hold an item on the Home screen, and then drag it to a new location.

You can also move frequently used apps to the shortcuts area at the bottom of the Home screen.

To move the item to another panel, drag it to the side of the screen.

To move an item more easily, tap and hold an item, and drag it to **Move apps** at the top of the screen. The item will move to the panel at the top of the screen. Swipe to the left or right to move to another panel and drag the item to a new location.

## Removing items

Tap and hold an item, and then drag it to **Remove** at the top of the screen.

## Creating folders

Create folders and gather similar applications to quickly access and launch apps.

- 1 On the Home screen, tap and hold an app, and then drag it over another app.
- 2 Drop the app when a folder frame appears around the apps.  
A new folder containing the selected apps will be created.

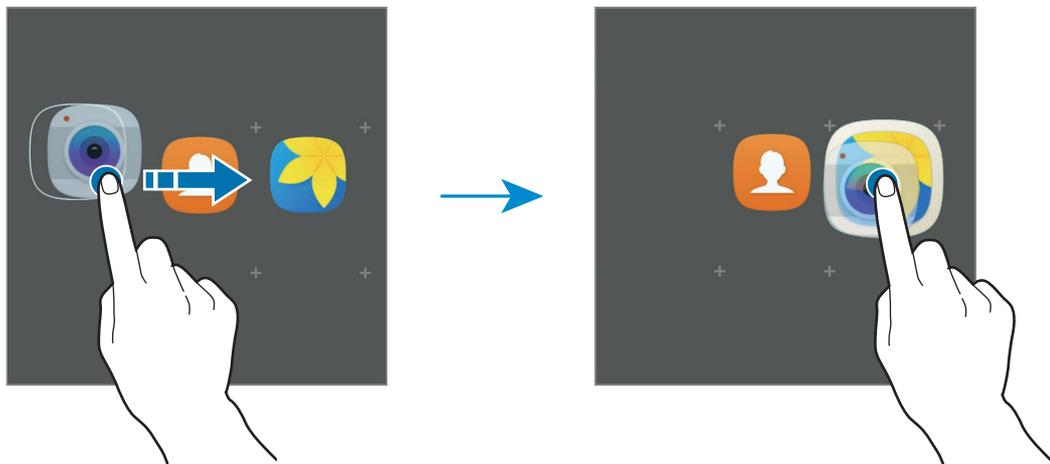

3 Tap **Enter folder name** and enter a folder name.

To change the folder colour, tap .

To add more apps to the folder, tap , tick the apps, and then tap **ADD**. You can also add an app by dragging it to the folder on the Home screen.

To move apps from a folder to the Home screen, tap the folder, and then drag an app to the Home screen.

To delete apps in a folder, tap the folder, and then drag the app you want to delete to **Remove** at the top of the screen.

## Managing panels

On the Home screen, tap and hold an empty area to add, move, or remove a panel.

To add a panel, swipe to the left, and then tap .

To move a panel, tap and hold a panel preview, and then drag it to a new location.

To remove a panel, tap and hold a panel preview, and then drag it to **Remove** at the top of the screen.

To set a panel as the main Home screen, tap .

## Apps screen

The Apps screen displays icons for all apps, including newly installed apps.

On the Home screen, tap **Apps** to open the Apps screen. To view other panels, swipe to the left or right.

## Moving items



This feature may not be available depending on the region or service provider.

On the Apps screen, tap **EDIT**. Tap and hold an item and drag it to a new location.

To move the item to another panel, drag it to the side of the screen.

## Creating folders

Create folders and gather similar applications to quickly access and launch apps you want.



This feature may not be available depending on the region or service provider.

- 1 On the Apps screen, tap **EDIT**.
- 2 Tap and hold an app, and then drag it over another app.
- 3 Drop the app when a folder frame appears around the apps.  
A new folder containing the selected apps will be created.

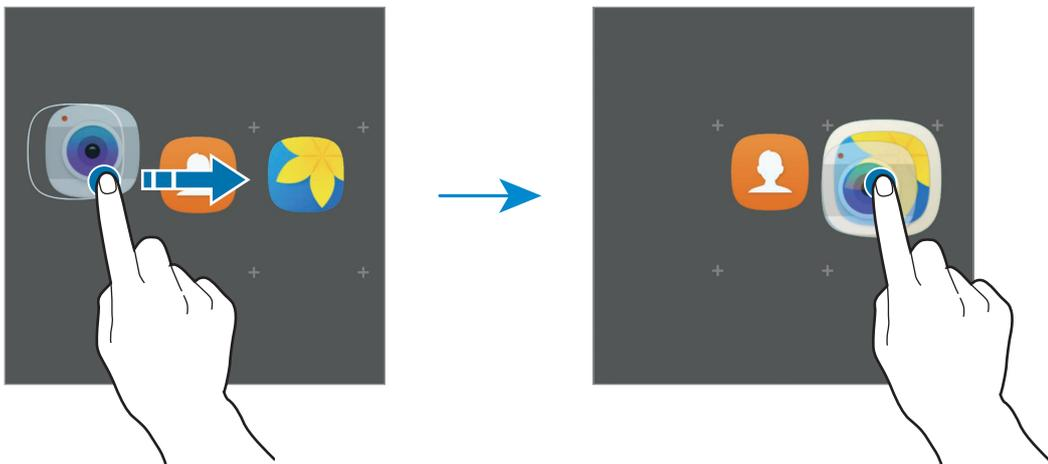

- 4 Tap **Enter folder name** and enter a folder name.

To change the folder colour, tap 🎨.

To add more apps to the folder, tap +, tick the apps, and then tap **ADD**. You can also add an app by dragging it to the folder on the Apps screen.

To delete a folder, select a folder with 🗑️. Only the folder will be deleted. The folder's apps will be relocated to the Apps screen.

## Rearranging items

You can rearrange items in alphabetical order on the Apps screen.

On the Apps screen, tap **A-Z** → **SAVE**.

## Searching for items

You can search for items on the Apps screen.

On the Apps screen, tap **SEARCH** and enter characters. The device will search for and display the items containing the characters you entered.

## Indicator icons

Indicator icons appear on the status bar at the top of the screen. The icons listed in the table below are most common.



The status bar may not appear at the top of the screen in some apps. To display the status bar, drag down from the top of the screen.

Icon	Meaning
	No signal
	Signal strength
	Currently accessing SIM or USIM card (dual SIM models)
	Roaming (outside of normal service area)
	GPRS network connected
	EDGE network connected
	UMTS network connected
	HSDPA network connected
	HSPA+ network connected
	LTE network connected (LTE-enabled models)
	Wi-Fi connected
	Bluetooth feature activated
	GPS activated

Icon	Meaning
	Call in progress
	Missed call
	New text or multimedia message
	Alarm activated
	Mute mode activated
	Vibration mode activated
	Flight mode activated
	Error occurred or caution required
	Battery power level

## Lock screen

Pressing the Power key turns off the screen and locks it. Also, the screen turns off and automatically locks if the device is not used for a specified period.

The screen is locked with **Swipe**, the default screen lock method.

Press the Power key or the Home key and swipe in any direction to unlock the screen.

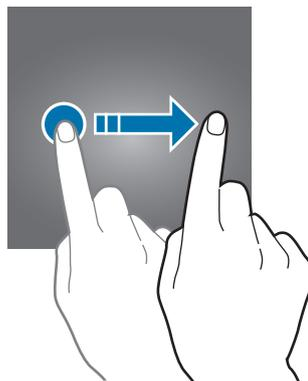

To change the screen lock method, on the Apps screen, tap **Settings** → **Lock screen and security** → **Screen lock type**, and then select a method.

When you set a pattern, PIN, password, or fingerprint for the screen lock method, you can protect your personal information by preventing others from accessing your device. After setting the screen lock method, the device will require an unlock code whenever unlocking it.

- **Swipe:** Swipe in any direction on the screen to unlock it.
- **Pattern:** Draw a pattern with four or more dots to unlock the screen.
- **PIN:** Enter a PIN with at least four numbers to unlock the screen.
- **Password:** Enter a password with at least four characters, numbers, or symbols to unlock the screen.
- **None:** Do not set a screen lock method.
- **Fingerprints:** Register your fingerprints to unlock the screen. Refer to [Fingerprint recognition](#) for more information.



- If the unlock code is forgotten, take the device to a Samsung Service Centre to reset it.
- You can set your device to perform a factory data reset if you enter the unlock code incorrectly several times in a row and reach the attempt limit. On the Apps screen, tap **Settings** → **Lock screen and security** → **Secure lock settings** and tap the **Auto factory reset** switch to activate it.

# Notification panel

## Using the notification panel

When you receive new notifications, such as messages or missed calls, indicator icons appear on the status bar. To see more information about the icons, open the notification panel and view the details.

To open the notification panel, drag the status bar downwards. To close the notification panel, swipe upwards on the screen.

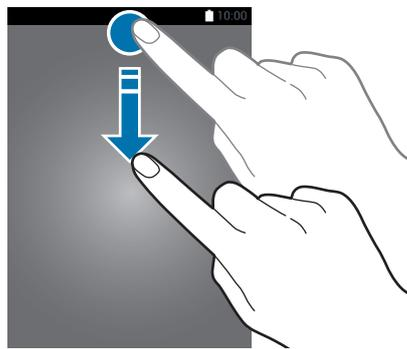

You can use the following functions on the notification panel.

► **Single SIM models:**

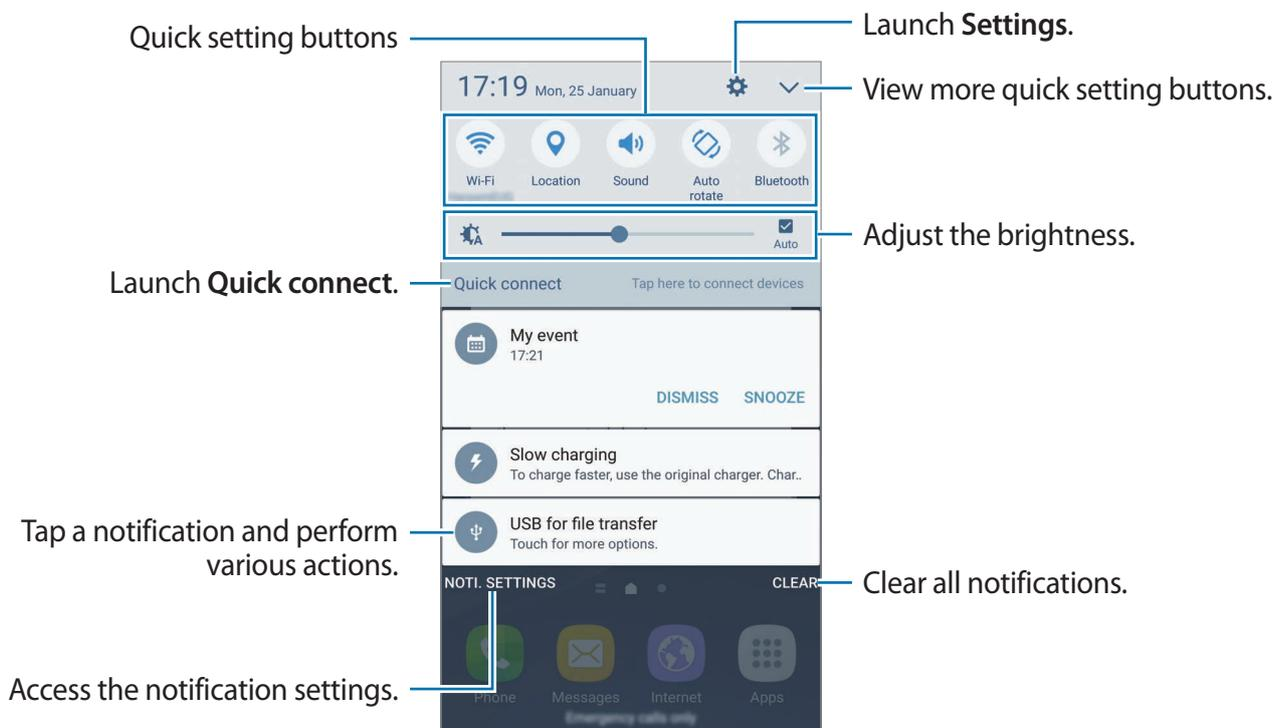

► **Dual SIM models:**

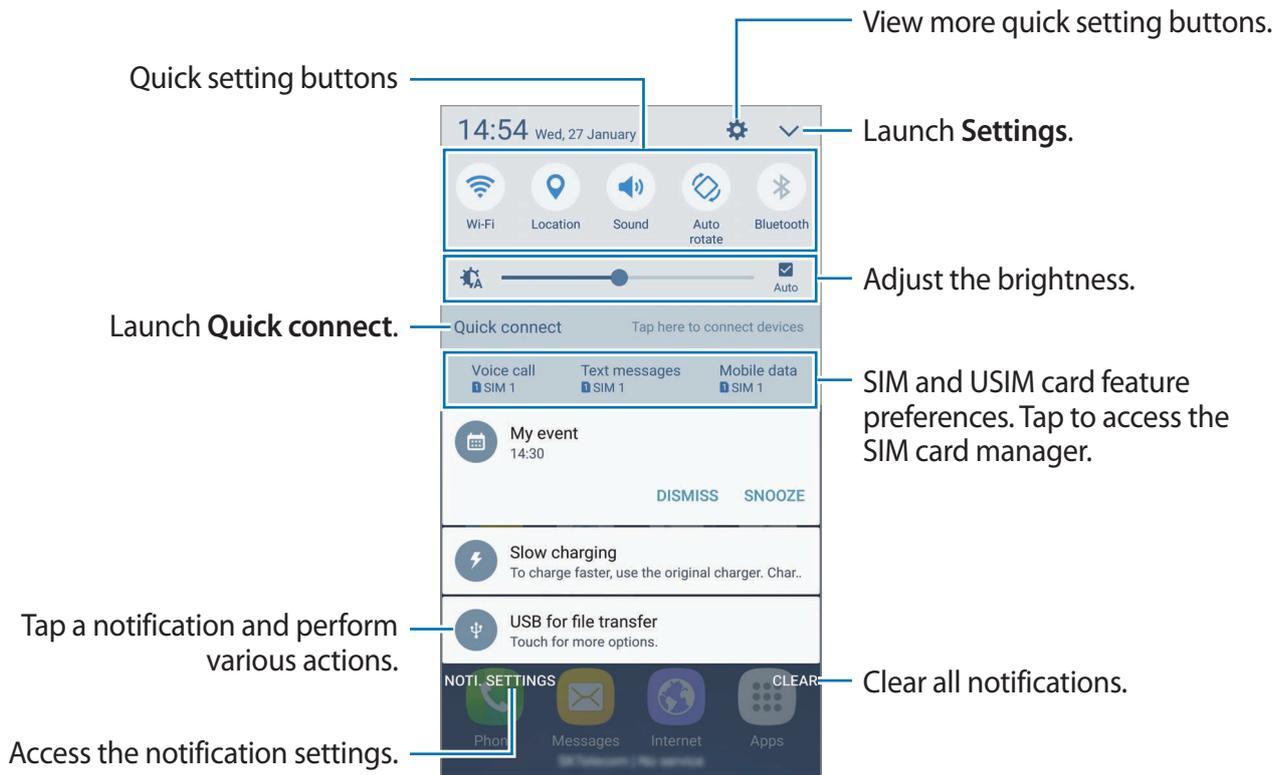

## Using quick setting buttons

Tap quick setting buttons to activate some features. Swipe to the left or right on the buttons area, or tap  to view more buttons. To view more detailed settings, tap and hold a button. To rearrange buttons, tap  → **EDIT**, tap and hold a button, and then drag it to another location.

## S Finder

Search for a wide variety of content with a keyword.

### Searching for content on the device

Open the notification panel and tap  → **S Finder**.

Enter a keyword in the search field or tap  and say a keyword.

To get more refined results, tap **Filter** under the search field, and then select filter details.

### Setting search categories

You can set search categories to search for content in specific search fields.

Tap **MORE** → **Select search locations** and select categories.

## Entering text

### Keyboard layout

A keyboard appears automatically when you enter text to send messages, create memos, and more.



Text entry is not supported in some languages. To enter text, you must change the input language to one of the supported languages.

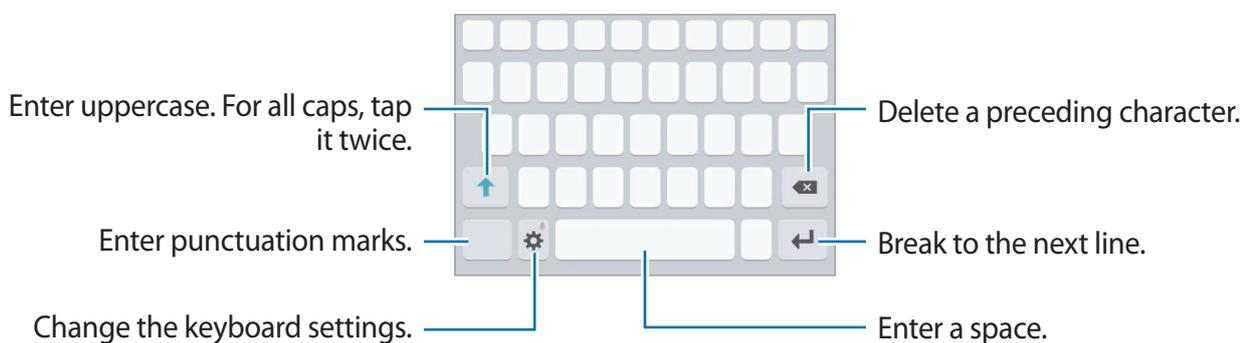

## Changing the input language

Tap  → **Add input languages**, and then select the languages to use. When you select two or more languages, you can switch between the input languages by swiping to the left or right on the space key.

## Changing the keyboard layout

Tap , select a language under **Languages and types**, and then select a keyboard layout to use.



On **3x4 keyboard**, a key has three or four characters. To enter a character, tap the corresponding key repeatedly until the desired character appears.

## Additional keyboard functions

Tap and hold  to use various functions. Other icons may appear instead of the  icon depending on the last function that was used.

-  : Enter text by voice.

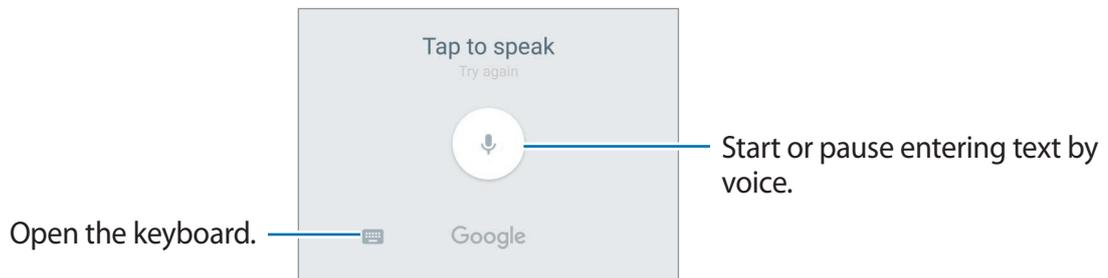

-  : Add an item from the clipboard.
-  : Enter emoticons.
-  : Change the keyboard settings.

## Copying and pasting

- 1 Tap and hold over text.
- 2 Drag  or  to select the desired text, or tap **Select all** to select all text.
- 3 Tap **Copy** or **Cut**.  
The selected text is copied to the clipboard.
- 4 Tap and hold where the text is to be inserted and tap **Paste**.  
To paste text that you have previously copied, tap **Clipboard** and select the text.

## Dictionary

Look up definitions for words while using certain features, such as when browsing webpages.

- 1 Tap and hold over a word that you want to look up.  
If the word you want to look up is not selected, drag  or  to select the desired text.
- 2 Tap **Dictionary** on the options list.  
If a dictionary is not preinstalled on the device, tap **Manage dictionaries** →  next to a dictionary to download it.
- 3 View the definition in the dictionary pop-up window.  
To switch to the full screen view, tap . Tap the definition on the screen to view more definitions. In the detailed view, tap  to add the word to your favourite words list or tap **Search Web** to use the word as a search term.

# Screen capture

Capture a screenshot while using the device.

## Capturing screenshots

Press and hold the Home key and the Power key simultaneously. You can view captured images in **Gallery**.

You can also capture screenshots by swiping your hand to the left or right across the screen. If this feature is not activated, open the Apps screen, tap **Settings** → **Advanced features** → **Palm swipe to capture** and tap the switch to activate it.



It is not possible to capture a screenshot while using some apps and features.

## Smart capture

You can capture the current screen and scrollable area. You can also immediately crop and share the captured screen.

If this feature is not activated, open the Apps screen, tap **Settings** → **Advanced features** → **Smart capture**, tap the switch to activate it, and then capture a screenshot. On the screen you are capturing, use one of the following options:

- **Capture more:** Capture more content that continues across multiple screens, such as a web page. The screen will automatically scroll down and more content will be captured.
- **Share:** Share the screenshot.
- **Crop:** Crop a portion from the screenshot.

## Opening apps

On the Home screen or the Apps screen, select an app icon to open it.

To open an app from the list of recently used apps, tap  and select a recent app window.

## Closing an app

Tap  and drag a recent app window to the left or right to close it. To close all running apps, tap **CLOSE ALL**.

## Multi window

### Introduction

Multi window lets you run two apps at the same time in the split screen view. You can also run multiple apps at the same time in the pop-up view.



Some apps may not support this feature.



Split screen view



Pop-up view

## Split screen view

- 1 Tap  to open the list of recently used apps.
- 2 Swipe upwards or downwards and tap  on a recent app window.  
The selected app will launch in the upper window.

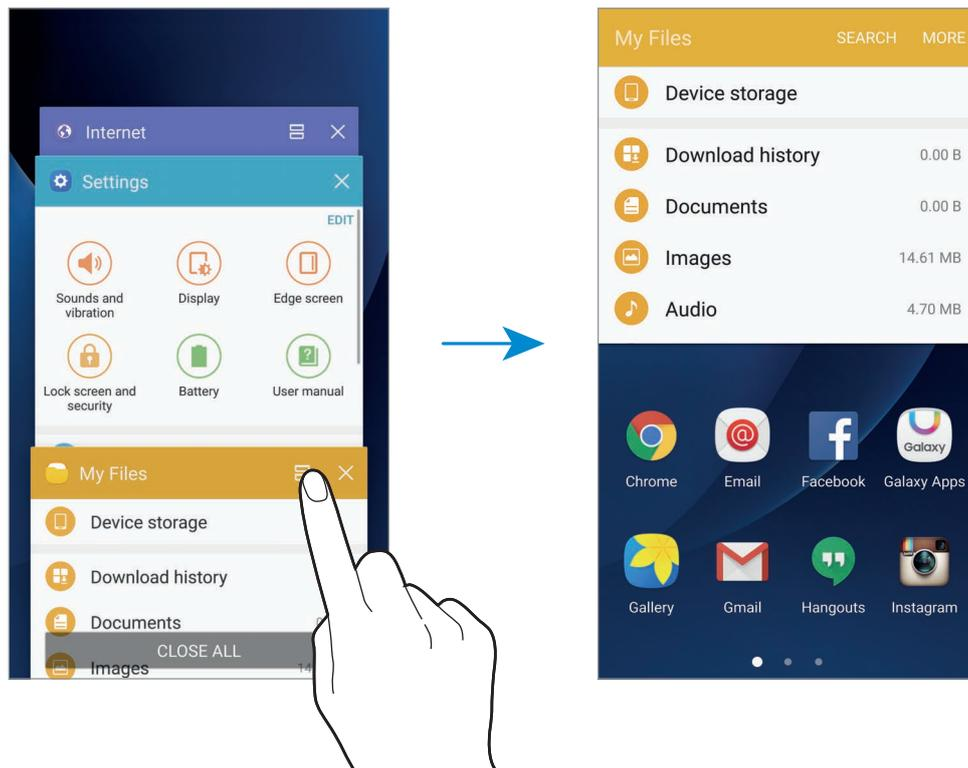

- 3 Swipe to the left or right to select another app to launch.



You can also launch the split screen view by tapping and holding .

## Using additional options

When using apps in the split screen view, select an app window and tap the circle between the app windows to access the following options:

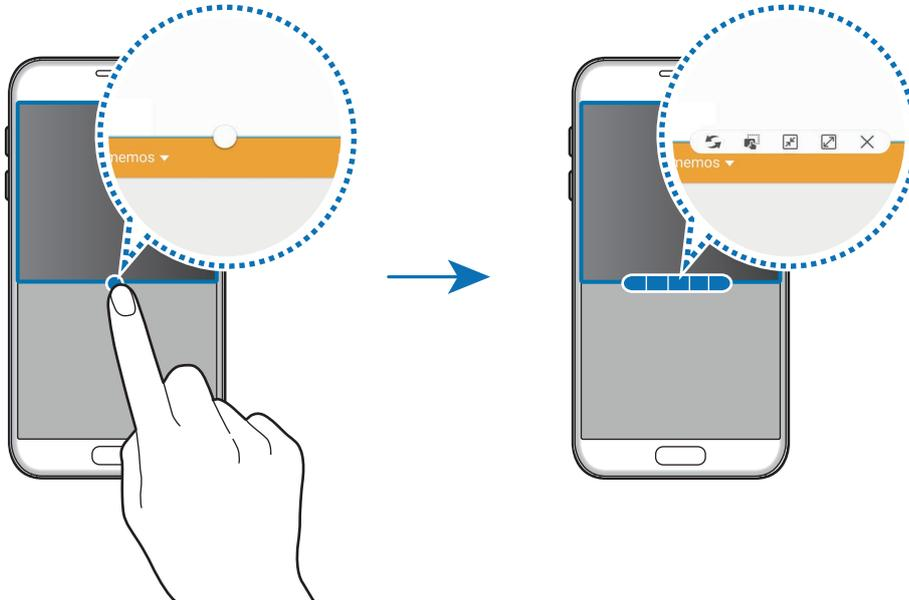

- : Switch locations between app windows.
- : Drag and drop text or copied images from one window to another. Tap and hold an item in the selected window and drag it to a location in another window.



Some apps may not support this feature.

- : Minimise the window.
- : Maximise the window.
- : Close the app.

## Adjusting the window size

Drag the circle between the app windows up or down to adjust the size of the windows.

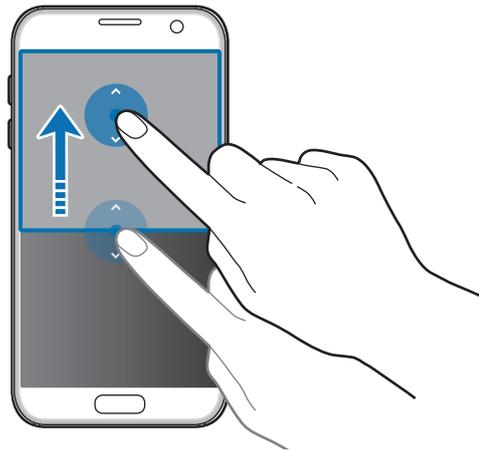

## Pop-up view

- 1 On the Apps screen, launch an app to use in the pop-up view.
- 2 Drag down diagonally from either end of the top edge.  
The app screen will appear in the pop-up view.

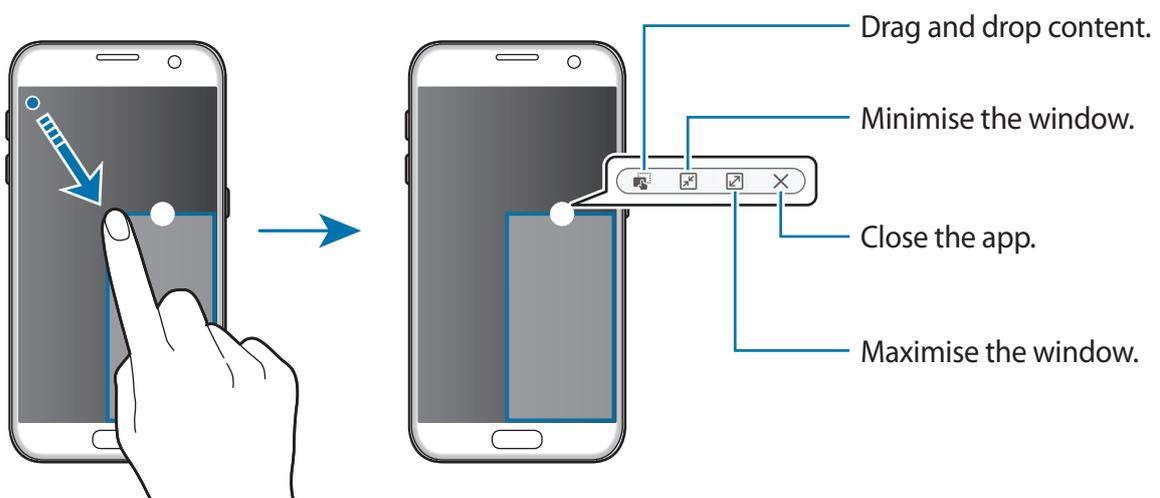

## Moving pop-up windows

To move a pop-up window, tap and hold the circle on a window and drag it to a new location.

# Samsung account

## Introduction

Your Samsung account is an integrated account service that allows you to use a variety of Samsung services provided by mobile devices, TVs, and the Samsung website. Once your Samsung account has been registered, you can use apps provided by Samsung, without signing in to your account.

Create your Samsung account with your email address.

To check the list of services that can be used with your Samsung account, visit [account.samsung.com](https://account.samsung.com). For more information on Samsung accounts, open the Apps screen and tap **Settings** → **Accounts** → **Samsung account** → **Help**.

## Registering your Samsung account

### Registering a new Samsung account

If you do not have a Samsung account, you should create one.

- 1 On the Apps screen, tap **Settings** → **Accounts** → **Add account**.
- 2 Tap **Samsung account** → **CREATE ACCOUNT**.
- 3 Follow the on-screen instructions to complete creating your account.

## Registering an existing Samsung account

If you already have a Samsung account, register it to the device.

**1** On the Apps screen, tap **Settings** → **Accounts** → **Add account**.

**2** Tap **Samsung account**.

**3** Enter your email address and password, and then tap **SIGN IN**.

If you forget your account information, tap **Forgotten your ID or password?** You can find your account information when you enter the required information and security code displayed that is on the screen.

## Removing your Samsung account

When you remove your registered Samsung account from the device, your data, such as contacts or events, will also be removed.

**1** On the Apps screen, tap **Settings** → **Accounts**.

**2** Tap **Samsung account** and tap the account to remove.

**3** Tap **MORE** → **Remove account** → **REMOVE ACCOUNT**.

**4** Enter your Samsung account password and tap **CONFIRM**.

**5** Tap **REMOVE ACCOUNT**.

## Transferring data from your previous device

You can transfer data from a previous device to your device via Samsung Smart Switch.

The following versions of Samsung Smart Switch are available.

- Mobile version: Transfer data between mobile devices. You can launch the mobile version app by tapping **Settings** → **Backup and reset** → **Open Smart Switch**. If you do not have the app, download it from **Galaxy Apps** or **Play Store**.
- Computer version: Transfer data between your device and a computer. You can download the app from [www.samsung.com/smartswitch](http://www.samsung.com/smartswitch).



- Samsung Smart Switch is not supported on some devices or computers.
- Limitations apply. Visit [www.samsung.com/smartswitch](http://www.samsung.com/smartswitch) for details. Samsung takes copyright seriously. Only transfer content that you own or have the right to transfer.

### Transferring data via a USB connection

You can connect your previous device to your device with the USB connector and a USB cable to easily and quickly transfer data without installing an app in the previous device.

- 1 Plug the USB connector into the multipurpose jack of your device.
- 2 Connect your device and the previous device using the USB cable.

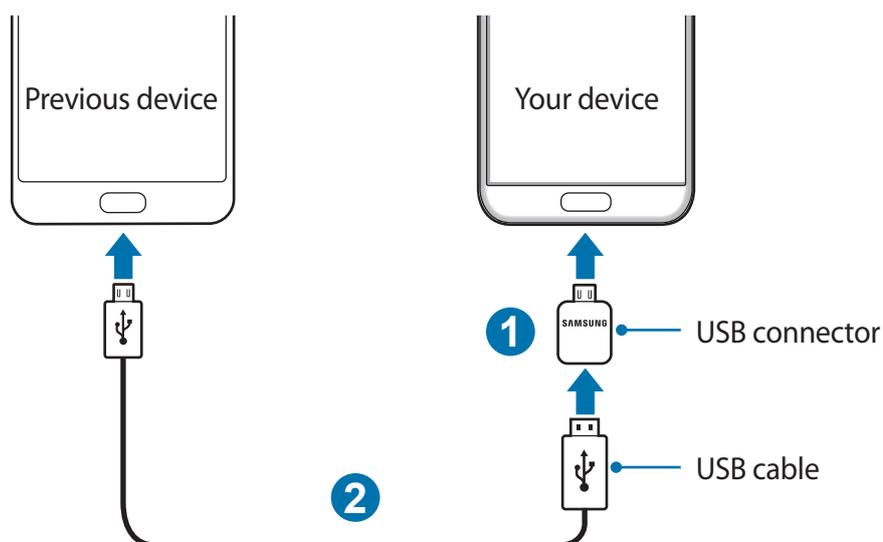

3 When the app selection pop-up window appears, tap **Smart Switch** → **START**.  
Your device will recognise the previous device and a list of data you can transfer will appear.

4 Follow the on-screen instructions to transfer data from the previous device.



Do not disconnect the USB cable or USB connector from the device when you are transferring files. Doing so may cause data loss or device damage.



Transferring data with the USB connector increases the battery power consumption. Ensure that the battery is fully charged before transferring data. If the battery power is low, data transfer may be interrupted.

## Transferring data wirelessly

Transfer data from your previous device to your device.

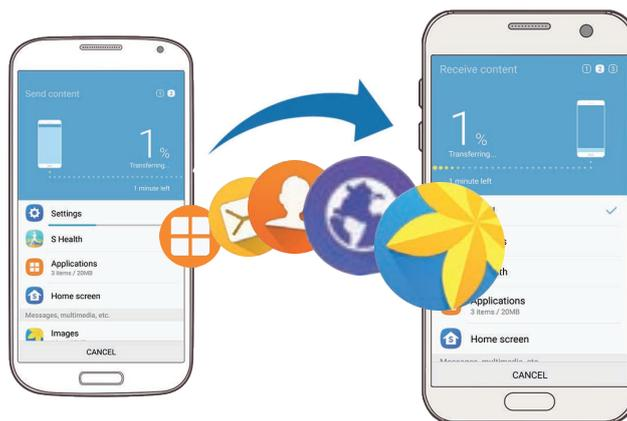

1 On the previous device, download and install **Smart Switch** from **Galaxy Apps** or **Play Store**. Then, launch **Smart Switch**.

2 Place the devices near each other.

- 3 On your device, open the Apps screen and tap **Settings** → **Backup and reset** → **Open Smart Switch**.
- 4 On your device, select the previous device type from the list and tap **START**.
- 5 Follow the on-screen instructions to transfer data from your previous device.

## Transferring backup data from a computer

Back up data from your previous device to a computer and import the data to your device.

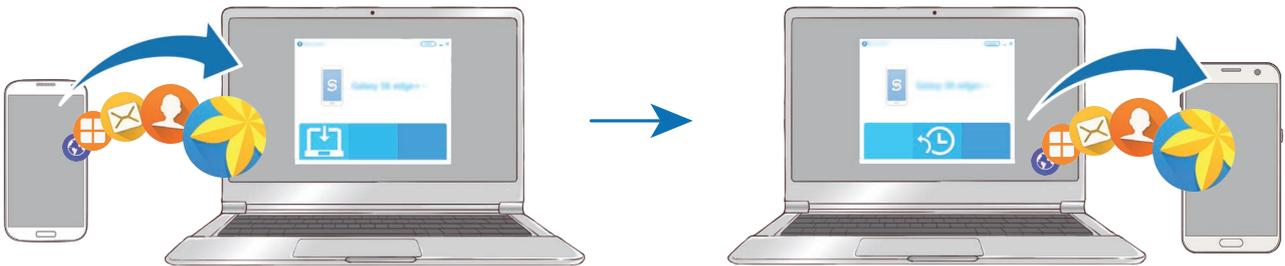

- 1 On the computer, visit [www.samsung.com/smartswitch](http://www.samsung.com/smartswitch) to download Smart Switch.
  - 2 On the computer, launch Smart Switch.
-  If your previous device is not a Samsung device, back up data to a computer using a program provided by the device's manufacturer. Then, skip to the fifth step.
- 3 Connect your previous device to the computer using the USB cable.
  - 4 On the computer, follow the on-screen instructions to back up data from the device. Then, disconnect your previous device from the computer.
  - 5 Connect your device to the computer using the USB cable.
  - 6 On the computer, follow the on-screen instructions to transfer data to your device.

# Device and data management

## Connecting the device to a computer for data transfer

Move audio, video, image, or other types of files from the device to the computer, or vice versa.



Do not disconnect the USB cable from the device when you are transferring files. Doing so may cause data loss or device damage.



The devices may not connect properly if they are connected via a USB hub. Directly connect the device to the computer's USB port.

- 1 Connect the device to the computer using the USB cable.
- 2 Open the notification panel, and then tap **USB for file transfer** → **Transferring media files**.  
If the computer cannot recognise your device, tap **Transferring images**.
- 3 Tap **ALLOW** to permit the computer to access your device's data.  
When the computer recognises your device, the device will appear in My PC.
- 4 Transfer files between your device and the computer.

## Updating the device

The device can be updated to the latest software.

### Updating over the air

The device can be directly updated to the latest software by the firmware over-the-air (FOTA) service.

On the Apps screen, tap **Settings** → **About device** → **Download updates manually**.



When you tap the **Download updates automatically** switch to activate it, updates will be downloaded when the device is connected to a Wi-Fi network.

## Updating with Smart Switch

Connect the device to a computer and update the device to the latest software.

- 1 On the computer, visit [www.samsung.com/smartswitch](http://www.samsung.com/smartswitch) to download and install Smart Switch.
  - 2 On the computer, launch Smart Switch.
  - 3 Connect the device to the computer using a USB cable.
  - 4 If a software update is available, follow the on-screen instructions to update the device.
-  Do not turn off the computer or disconnect the USB cable while the device is updating.
  - While updating the device, do not connect other media devices to the computer. Doing so may interfere with the update process. Before updating, disconnect all other media devices from the computer.

## Backing up and restoring data

Keep your personal information, app data, and settings safe on your device. You can back up your sensitive information to a backup account and access it later. You must sign in to your Google or Samsung account to back up or restore data. Refer to [Samsung account](#) and [Accounts](#) for more information.

### Using a Samsung account

On the Apps screen, tap **Settings** → **Backup and reset** → **Back up my data** for the Samsung account, tap the switches next to the items you want to back up to activate them, and then tap **BACK UP NOW**.

To set the device to automatically back up data, tap the **Auto back up** switch to activate it.

To restore data using a Samsung account, tap **Restore**. Current data will be deleted from the device to restore the selected items.

## Using a Google account

On the Apps screen, tap **Settings** → **Backup and reset** → **Back up my data** for the Google account, and then tap the switch to activate it. Tap **Backup account** and select an account as the backup account.

To restore data using a Google account, tap the **Automatic restore** switch to activate it. When you reinstall apps, backed up settings and data will be restored.

## Performing a data reset

Delete all settings and data on the device. Before performing a factory data reset, ensure you back up all important data stored on the device. Refer to [Backing up and restoring data](#) for more information.

On the Apps screen, tap **Settings** → **Backup and reset** → **Factory data reset** → **RESET DEVICE** → **ERASE EVERYTHING**. The device automatically restarts.

# Quick connect

## Introduction

Quickly search for and connect with nearby devices, such as Bluetooth headsets or TVs, using the Quick connect feature.



- If the device you want to connect does not support the Quick connect feature, activate its Wi-Fi Direct or Bluetooth feature before launching **Quick connect** on your device.
- Connection methods may vary depending on the type of connected devices or the shared content.

## Connecting to other devices

- 1 Open the notification panel and tap **Quick connect**.

The Wi-Fi and Bluetooth features are activated automatically.



If **Quick connect** is not visible on the notification panel, tap  → **EDIT** and tap the **Quick connect** switch to activate it.

- 2 Tap **Scan for nearby devices**.

If there is no previously connected device, the device will automatically search for nearby devices.

- 3 Select a device from the list and connect to it by following the on-screen instructions.

The next steps may vary depending on the connected device.

To change your device's visibility setting, tap **MORE** → **Settings** → **Device visibility**, and then select an option.

## Sharing content

Share content with the connected devices.

- 1 Open the notification panel and tap **Quick connect**.

- 2 Tap **Scan for nearby devices**.

- 3 Select a device from the list of detected devices.

- 4 Tap **Share content** and select a media category.

- 5 Follow the on-screen instructions to send content to the connected device.

The next steps may vary depending on the selected media category.

## Connecting to a TV

Connect your device and a TV to view the device's content on the larger screen. You may be able to use more features depending on the connected TV.

- 1 Turn on the TV and place your device close to the TV.
- 2 Open the notification panel and tap **Quick connect** → **Scan for nearby devices**.
- 3 Select the TV.

The list of features you can use with the TV appears.

- 4 Select a feature and follow the on-screen instructions to use the feature.

Available features may vary depending on the TV.

- **Smart View:** View your device's content on the TV screen. You may need to activate the Screen Mirroring feature on the TV depending on the TV you want to connect. If the TV does not support the Screen Mirroring feature, use compatible accessories to enable the feature. Compatible accessories include HomeSync and an AllShare Cast dongle.
- **TV to mobile device:** Watch TV on your device's screen. You can continue watching TV within the allowed connection range.
- **Control TV:** Use your device as a remote control for the TV.
- **TV sound to mobile device:** Listen to the sound via the device's speaker while watching the TV. You can connect a headset to the device so that others do not hear the TV sound.

- **Briefing on TV:** Set the TV to turn on automatically according to the preset time set on your device and to display the time, weather, and your schedule information on the screen. To use this feature, your device and the TV must be connected to the same access point.
- **Register TV / Deregister TV:** Register the TV to your device to use additional features, such as **Control TV** and **Briefing on TV**.



- Some files may be buffered during playback, depending on the connection.
- If the TV does not support High-bandwidth Digital Content Protection (HDCP), you cannot view Digital Rights Management (DRM)-protected content on the TV.

## Streaming content on the registered TV

If you register a TV to your device, you can more easily connect to the TV while playing content.

When your device recognises the registered TV while you are watching content, the  icon will appear on the device. Tap the icon to stream the content from your device to your TV.



- This feature is supported only by the device's default gallery app.
- When the registered TV is connected to an electric socket, you can use this feature even if the TV screen is turned off.

## Sharing features

Share content by using various sharing options. The following actions are an example of sharing images.



You may incur additional charges when sharing files via the mobile network.

- 1 Tap **Gallery** on the Apps screen.
- 2 Select an image.
- 3 Tap **Share** and select a sharing method, such as Bluetooth and email.

You can also use the following options:

- **Simple sharing:** Share content with your contacts. To use this feature, your phone number must be verified.



- This feature may not be available depending on the region or service provider.
- If the recipients have not verified their phone numbers or if their devices do not support the feature, a link to the files will be sent to them via text message. The link will expire after a certain period.
- **Smart View:** View your device's displayed content on a larger screen via a wireless connection.
- **Nearby sharing:** Share content with nearby devices via Wi-Fi Direct, Bluetooth, and more.
- **Print:** Print content using the printer plug-ins installed on the device.

- 4 Follow the on-screen instructions to share the image with others.

When the image is sent to the recipients' devices, a notification will appear on their devices. Tap the notification to view or download the image.

## Emergency mode

Emergency mode changes the screen to grey tones to reduce battery consumption. Some apps and functions will be restricted. In emergency mode, you can make an emergency call, send your current location information to others, sound an emergency alarm, and more.

Press and hold the Power key, and then tap **Emergency mode**.

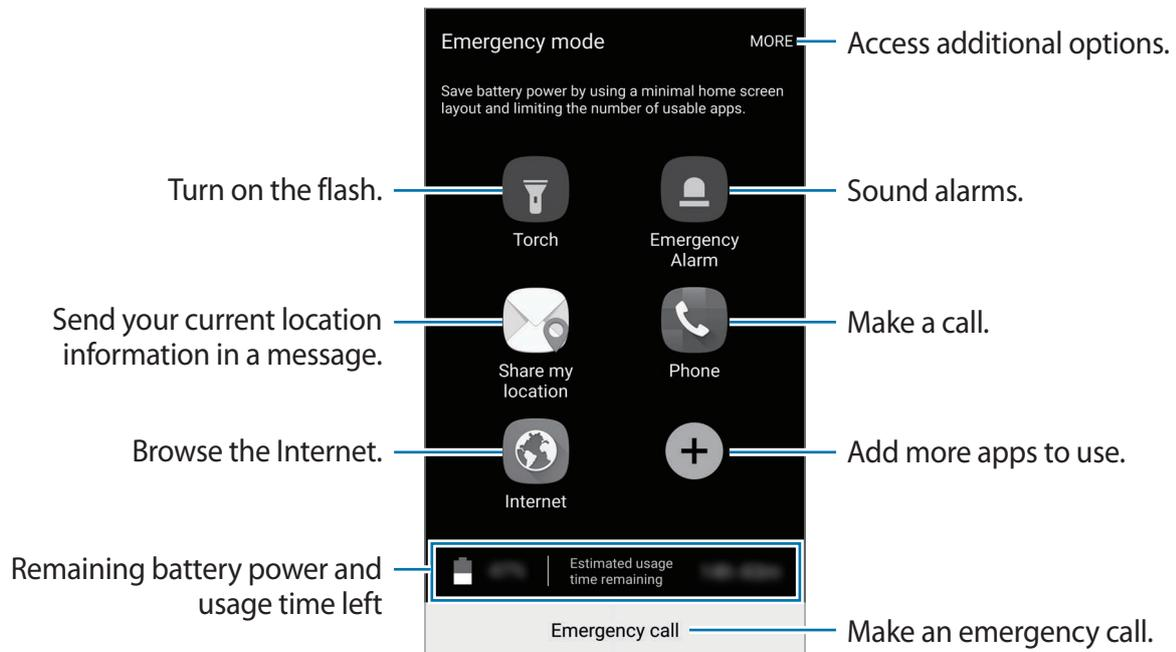

The usage time left shows the time remaining before the battery power runs out. Usage time left may vary depending on your device settings and operating conditions.

## Deactivating emergency mode

To deactivate emergency mode, tap **MORE** → **Disable Emergency mode**. Alternatively, press and hold the Power key, and then tap **Emergency mode**.

# Applications

## Installing or uninstalling apps

### Galaxy Apps

Purchase and download apps. You can download apps that are specialised for Samsung Galaxy devices.

Tap **Samsung** → **Galaxy Apps** on the Apps screen.



This app may not be available depending on the region or service provider.

### Installing apps

Browse apps by category or tap **SEARCH** to search for a keyword.

Select an app to view information about it. To download free apps, tap **INSTALL**. To purchase and download apps where charges apply, tap the price and follow the on-screen instructions.



To change the auto update settings, tap **MORE** → **Settings** → **Auto update apps**, and then select an option.

### Play Store

Purchase and download apps.

Tap **Play Store** on the Apps screen.

### Installing apps

Browse apps by category or search for apps by keyword.

Select an app to view information about it. To download free apps, tap **INSTALL**. To purchase and download apps where charges apply, tap the price and follow the on-screen instructions.



To change the auto update settings, tap **≡** → **Settings** → **Auto-update apps**, and then select an option.

## Managing apps

### Uninstalling or disabling apps

On the Apps screen, tap **EDIT**. The  icon appears on the apps that you can disable or uninstall. Select an app and tap **DISABLE** or **OK**. Alternatively, on the Apps screen, tap **Settings** → **Applications** → **Application manager**, select an app, and then tap **DISABLE** or **UNINSTALL**.

- **DISABLE**: Disable selected default apps that cannot be uninstalled from the device.
- **UNINSTALL**: Uninstall downloaded apps.

### Enabling apps

On the Apps screen, tap **Settings** → **Applications** → **Application manager** →  → **Disabled**, select an app, and then tap **ENABLE**.

### Setting app permissions

For some apps to operate properly, they may need permission to access or use information on your device. When you open an app, a pop-up window may appear and request access to certain features or information. Tap **ALLOW** on the pop-up window to grant permissions to the app.

To view your app permission settings, open the Apps screen and tap **Settings** → **Applications** → **Application manager**. Select an app and tap **Permissions**. You can view the app's permissions list and change its permissions.

To view or change app permission settings by permission category, open the Apps screen, tap **Settings** → **Privacy and safety** → **App permissions**. Select an item and tap the switches next to apps to grant permissions.



If you do not grant permissions to apps, the basic features of the apps may not function properly.

# Phone

## Introduction

Make or answer voice and video calls.

## Making calls

- 1 Tap **Phone** on the Apps screen.
- 2 Enter a phone number.  
If the keypad does not appear on the screen, tap  to open the keypad.
- 3 ► **Single SIM models:** Tap  to make a voice call, or tap  to make a video call.

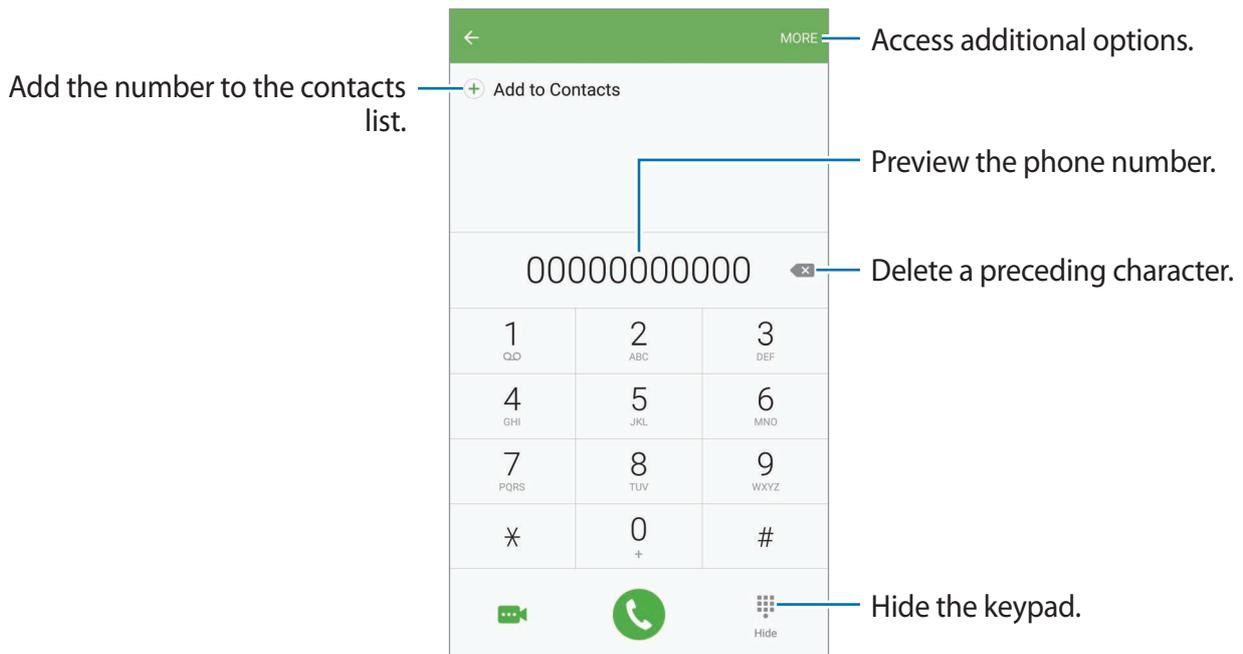

► **Dual SIM models:** Tap  or  to make a voice call, or tap  to make a video call.

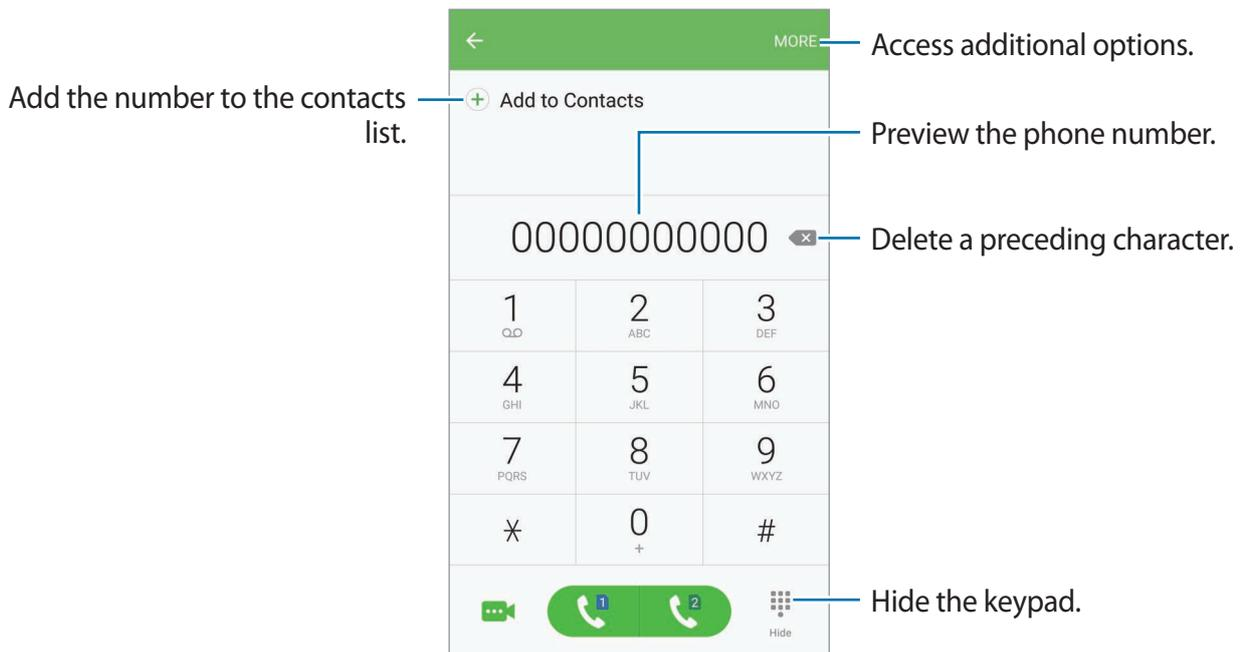

## Using speed dial

Set speed dial numbers to quickly make calls.

To set a number to speed dial, tap **MORE** → **Speed dial**, select a speed dial number, and then select a contact.

To make a call, tap and hold a speed dial number on the keypad. For speed dial numbers 10 and up, tap the first digit(s) of the number, and then tap and hold the last digit.

For example, if you set the number **123** as a speed dial number, tap **1**, tap **2**, and then tap and hold **3**.

## Making calls from the locked screen

On the locked screen, drag  outside the large circle.

## Making calls from call logs or contacts list

Tap **LOG** or **CONTACTS**, and then swipe to the right on a contact or a phone number to make a call.

## Making an international call

- 1 Tap  to open the keypad if the keypad does not appear on the screen.
- 2 Tap and hold **0** until the + sign appears.
- 3 **▶ Single SIM models:** Enter the country code, area code, and phone number, and then tap .  
**▶ Dual SIM models:** Enter the country code, area code, and phone number, and then tap  or .

## Receiving calls

### Answering a call

When a call comes in, drag  outside the large circle.

### Rejecting a call

When a call comes in, drag  outside the large circle.

To send a message when rejecting an incoming call, drag the reject message bar upwards.

To create various rejection messages, open the Apps screen, tap **Phone** → **MORE** → **Settings** → **Call blocking** → **Call-reject messages**, enter a message, and then tap .

### Missed calls

If a call is missed, the  icon appears on the status bar. Open the notification panel to view the list of missed calls. Alternatively, on the Apps screen, tap **Phone** → **LOG** to view missed calls.

## Blocking phone numbers

Block calls from specific numbers added to your block list.

1 On the Apps screen, tap **Phone** → **MORE** → **Settings** → **Call blocking** → **Block list**.

2 Tap **LOG** or **CONTACTS** to select contacts and tap .

To manually enter a number, tap **Enter phone number**, and then enter a phone number.

When blocked numbers try to contact you, you will not receive notifications. The calls will be logged in the call log.



You can also block incoming calls from people that do not show their caller ID. Tap the **Block anonymous calls** switch to activate the feature.

## Options during calls

### During a voice call

The following actions are available:

- **HOLD:** Hold a call. Tap **RESUME CALL** to retrieve the held call.
- **Add call:** Dial a second call.
- **Extra volume:** Increase the volume.
- **Bluetooth:** Switch to a Bluetooth headset if it is connected to the device.
- **Speaker:** Activate or deactivate the speakerphone. When using the speakerphone, speak into the microphone at the top of the device and keep the device away from your ears.
- **Keypad / Hide:** Open or close the keypad.
- **Mute:** Turn off the microphone so that the other party cannot hear you.
- **Email:** Send an email.
- **Message:** Send a message.
- **Internet:** Browse webpages.
- **Contacts:** Open the contacts list.
- **S Planner:** Open the calendar.
- **Memo:** Create a memo.
- : End the current call.

## During a video call

Tap the screen to use the following options:

- **MORE:** Access additional options.
- **Switch:** Switch between the front and rear cameras.
- : End the current call.
- **Mute:** Turn off the microphone so that the other party cannot hear you.

# Contacts

## Introduction

Create new contacts or manage contacts on the device.

## Adding contacts

### Creating contacts manually

- 1 Tap **Contacts** on the Apps screen.
- 2 Tap  and select a storage location.
- 3 Enter contact information.
  - : Add an image.
  -  / : Add or delete a contact field.
- 4 Tap **SAVE**.

To add a phone number to the contacts list from the keypad, open the Apps screen and tap **Phone**. If the keypad does not appear on the screen, tap  to open the keypad. Enter the number and tap **Add to Contacts**.

To add a phone number to the contacts list from received calls, open the Apps screen and tap **Phone** → **LOG** → a contact.

### Importing contacts

Import contacts from storage services to your device.

On the Apps screen, tap **Contacts** → **MORE** → **Settings** → **Import/Export contacts** → **IMPORT** and select an import option.

### Searching for contacts

On the Apps screen, tap **Contacts**.

Use one of the following search methods:

- Scroll up or down the contacts list.
- Drag a finger along the index at the right side of the contacts list to scroll through it quickly.
- Tap the search field at the top of the contacts list and enter search criteria.

Once a contact is selected, take one of the following actions:

-  : Add to favourite contacts.
-  /  : Make a voice or video call.
-  : Compose a message.
-  : Compose an email.

## Sharing profile

Share your profile information, such as your photo and status message, with others using the profile sharing feature.



- This feature may not be available depending on the region or service provider.
- This feature is only available for contacts who have activated the profile sharing feature on their device.

On the Apps screen, tap **Contacts** → your profile → **Profile sharing**, and then tap the switch to activate it. To use this feature, your phone number must be verified. You can view your contacts' updated profile information in **Contacts**.

To set additional items to share, tap **Shared profile info** and select items.

To set a contact group to share your profile with, tap **Share with** and select an option.

## Sharing contacts

You can share contacts with others by using various sharing options.

- 1 Tap **Contacts** on the Apps screen.
- 2 Tap **MORE** → **Share**.
- 3 Tick contacts and tap **SHARE**.
- 4 Select a sharing method.

# Messages

## Introduction

Send and view messages by conversation.

## Sending messages



You may incur additional charges for sending messages when you are roaming.

- 1 Tap **Messages** on the Apps screen.
- 2 Tap .
- 3 Add recipients and enter a message.
  - ▶ **Single SIM models:**

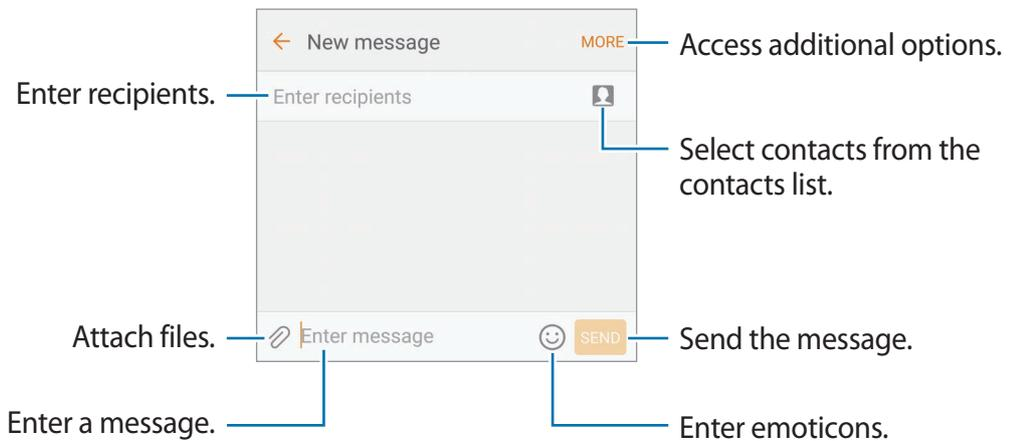

► **Dual SIM models:**

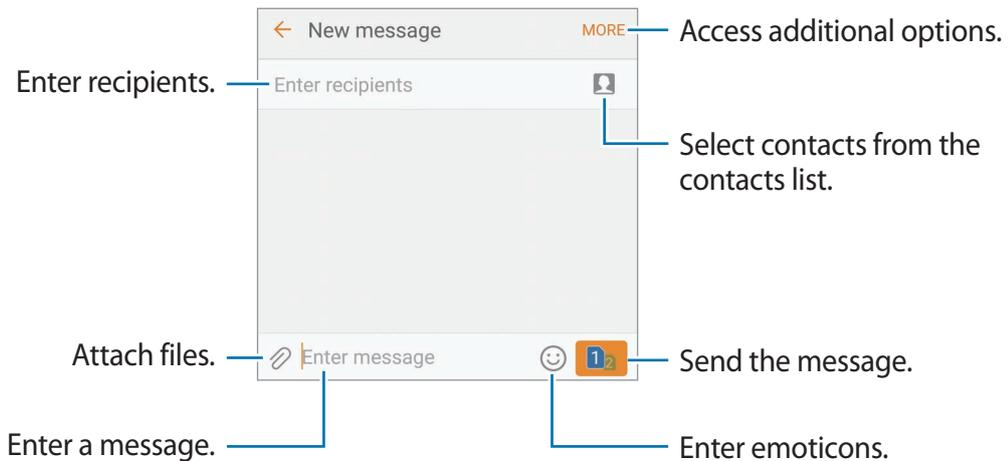

4 ► **Single SIM models:** Tap **SEND** to send the message.

► **Dual SIM models:** Tap **SEND<sup>1</sup>** or **SEND<sup>2</sup>** to send the message.

## Viewing messages

Messages are grouped into message threads by contact.



You may incur additional charges for receiving messages when you are roaming.

- 1 Tap **Messages** on the Apps screen.
- 2 On the messages list, select a contact.
- 3 View your conversation.

## Blocking unwanted messages

Block messages from specific numbers or messages that contain phrases added to your block list.

- 1 Tap **Messages** on the Apps screen.
- 2 Tap **MORE** → **Settings** → **Block messages**.

### 3 Tap **Block list**.

To add phrases to block, tap **Blocked phrases**.

### 4 Tap **INBOX** or **CONTACTS** to select contacts and tap .

To manually enter a number, tap **Enter number**, and then enter a phone number.

When you receive messages from the blocked numbers or messages including blocked phrases, you will not be notified. To view blocked messages, tap **MORE** → **Settings** → **Block messages** → **Blocked messages**.

## Setting the message notification

You can change notification sound, display options, and more.

### 1 Tap **Messages** on the Apps screen.

### 2 Tap **MORE** → **Settings** → **Notifications**, and then tap the switch to activate it.

### 3 Change the notification settings.

- **Notification sound:** Change the notification sound.
- **Vibrate:** Set the device to vibrate when you receive messages.
- **Pop-up display:** Set the device to display messages in pop-up windows.
- **Preview message:** Set the device to display message content on the locked screen and in pop-up windows.

## Setting a message reminder

You can set an alert at an interval to let you know that you have unchecked notifications. If this feature is not activated, open the Apps screen, tap **Settings** → **Accessibility** → **Notification reminder**, and then tap the switch to activate it. Then, tap the **Messages** switch to activate it.

# Internet

## Introduction

Browse the Internet to search for information and bookmark your favourite webpages to access them conveniently.

## Browsing webpages

- 1 Tap **Samsung** → **Internet** on the Apps screen.
- 2 Tap the address field.
- 3 Enter the web address or a keyword, and then tap **Go**.

To view the toolbars, drag your finger downwards slightly on the screen.

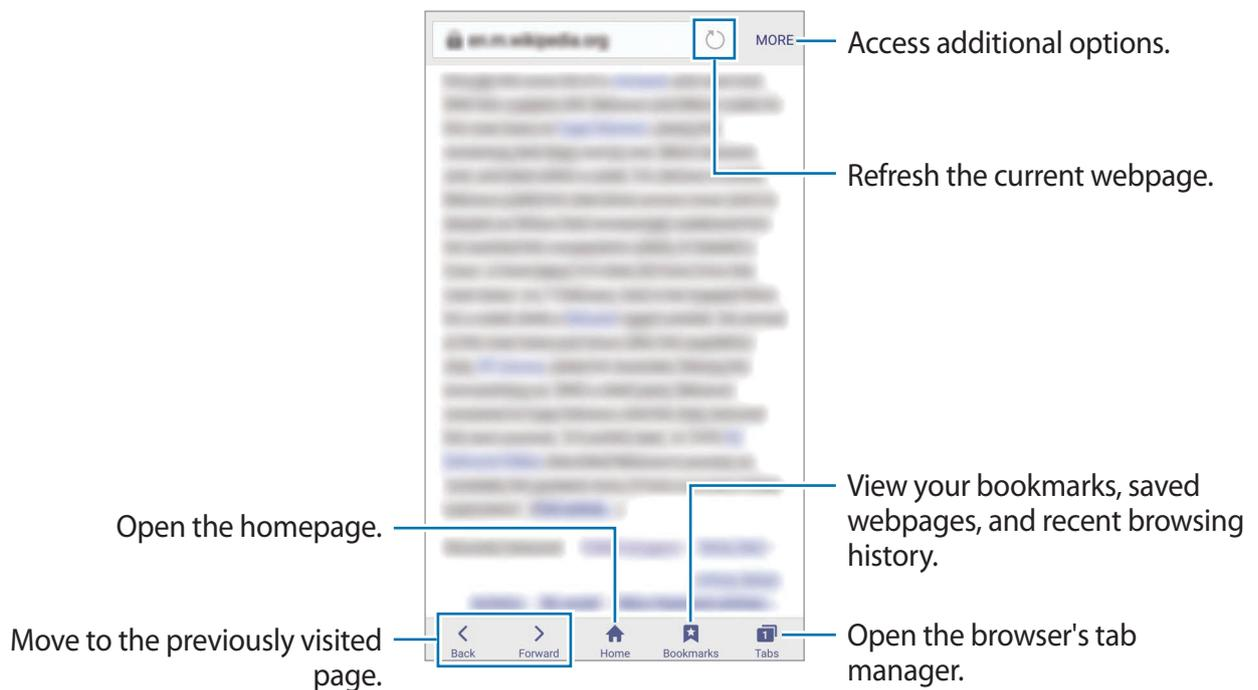

## Using secret mode

In secret mode, you can separately save and manage open tabs, bookmarks, and saved pages. You can lock secret mode using a password and your fingerprint.

### Activating secret mode

In the toolbar at the bottom of the screen, tap **Tabs** → **ENABLE SECRET**. If you are using this feature for the first time, set whether to use a password for secret mode.



In secret mode, you cannot use some features, such as screen capture.

In secret mode, the device will change the colour of the toolbars.

### Changing security settings

You can change your password or the lock method.

Tap **MORE** → **Settings** → **Privacy** → **Secret mode security** → **Change password**. To set your registered fingerprint as the lock method along with the password, tap the **Fingerprints** switch to activate it. Refer to [Fingerprint recognition](#) for more information about using your fingerprints.

### Deactivating secret mode

In the toolbar at the bottom of the screen, tap **Tabs** → **DISABLE SECRET**. Alternatively, close the Internet app.

# Email

## Setting up email accounts

Set up an email account when opening **Email** for the first time.

- 1 Tap **Samsung** → **Email** on the Apps screen.
- 2 Enter the email address and password, and then tap **SIGN IN**.  
To manually register a company email account, tap **MANUAL SETUP**.
- 3 Follow the on-screen instructions to complete the setup.

To set up another email account, tap **MORE** → **Settings** → **Add account**.

If you have more than one email account, you can set one as the default account. Tap **MORE** → **Settings** → **MORE** → **Set default account**.

## Sending emails

- 1 Tap  to compose an email.
- 2 Add recipients and enter an email text.
- 3 Tap **SEND** to send the mail.

## Reading emails

When **Email** is open, the device will automatically retrieve new emails. To manually retrieve emails, swipe downwards on the screen.

Tap an email on the screen to read it.



If email syncing is disabled, new emails cannot be retrieved. To enable email syncing, tap **MORE** → **Settings** → your account name, and then tap the **Sync account** switch to activate it.

# Camera

## Introduction

Take photos and record videos using various modes and settings.

## Basic shooting

You can take photos or record videos. View your photos and videos in **Gallery**.

Tap **Camera** on the Apps screen.

### Camera etiquette

- Do not take photos or record videos of other people without their permission.
- Do not take photos or record videos where legally prohibited.
- Do not take photos or record videos in places where you may violate other people's privacy.

## Taking photos or recording videos

- 1 Tap the image on the preview screen where the camera should focus.
- 2 Tap  to take a photo or tap  to record a video. To take a series of photos, tap and hold .
  - Spread two fingers apart on the screen to zoom in, and pinch to zoom out.
  - To adjust the brightness of photos or videos, tap the screen. When the adjustment bar appears, drag the adjustment bar towards **+** or **-**.
  - To capture an image from the video while recording, tap **Capture**.
  - To change the focus while recording a video, tap where you want to focus. To focus on the centre of the screen, tap .



On the preview screen, swipe to the right to access the list of shooting modes. Or, swipe to the left to view photos and videos you have captured.



- The preview screen may vary depending on the shooting mode and which camera is being used.
- The camera automatically shuts off when unused.
- Make sure that the lens is clean. Otherwise, the device may not work properly in some modes that require high resolutions.
- The front camera features a wide-angle lens. Minor distortion may occur in wide-angle photos and does not indicate device performance problems.
- The maximum recording time may reduce when you record video at high resolution.

## Launching Camera on the locked screen

To quickly take photos, launch **Camera** on the locked screen.

On the locked screen, drag  outside the large circle.



- This feature may not be available depending on the region or service provider.
- Some camera features are not available when you launch **Camera** from the locked screen while the security features are activated.

## Launching Camera quickly

Press the Home key twice quickly to launch **Camera**.



Some camera features are not available when you launch **Camera** from the locked screen or when the screen is turned off while the security features are activated.

## HDR (High Dynamic Range)

Take photos with rich colours and reproduce details even in bright and dark areas.

To activate or deactivate HDR mode, open the preview screen and tap **HDR** until you reach the desired option.

- **Auto:** The device automatically activates HDR mode depending on the shooting conditions.
- **On:** HDR mode is activated.
- **Off:** HDR mode is deactivated.

## Locking the focus and exposure

Strong light/dark contrast and the subject being outside the auto focus area may make it difficult to achieve an appropriate exposure. Lock the focus or exposure and then take a photo. Tap and hold the area to focus, the AF/AE frame will appear on the area and the focus and exposure setting will be locked. The setting remains locked even after you take a photo.



This feature is only available in some shooting modes.

## Customising shooting modes

On the preview screen, tap **MODE** and select a mode.

To view information for each mode, tap **INFO**.

To rearrange modes, tap **MORE** → **Edit**, tap and hold a mode icon, and then drag it to a new location.

To add mode shortcuts to the Home screen, tap **MORE** → **Add shortcut on home screen**.

## Auto mode

Auto mode allows the camera to evaluate the surroundings and determine the ideal mode for the photo.

On the preview screen, tap **MODE** → **Auto**.

## Pro mode

Take photos while manually adjusting various shooting options, such as exposure value and ISO value.

On the preview screen, tap **MODE** → **Pro**. Select options and customise the settings, and then tap  to take a photo.

- : Select a colour tone. To create your own colour tone, tap **Tone 1** or **Tone 2**.
- : Change the focus mode. Drag the adjustment bar towards  or  to manually adjust the focus. To switch to auto focus mode, drag the adjustment bar towards **Auto**.
- **WB**: Select an appropriate white balance, so images have a true-to-life colour range. You can set the colour temperature. Tap  and drag your finger on the colour temperature bar.
- **ISO**: Select an ISO value. This controls camera light sensitivity. Low values are for stationary or brightly lit objects. Higher values are for fast-moving or poorly lit objects. However, higher ISO settings can result in noise in photos.



If the shutter speed is set manually, you cannot set the ISO setting to **Auto**.

- : Adjust the shutter speed. A slow shutter speed allows more light in, so the photo becomes brighter. This is ideal for photos of scenery or pictures taken at night. A fast shutter speed allows less light in. This is ideal for taking photos of fast-moving subjects.
- : Change the exposure value. This determines how much light the camera's sensor receives. For low-light situations, use a higher exposure.



If the shutter speed is set manually, you cannot change the exposure value. The exposure value will change and be displayed based on the shutter speed setting.

## Saving the current setting as a custom setting

On the preview screen, tap **Custom** → **Save current settings**, select a name, and then tap **SAVE**.

To apply the saved settings to the camera, open the preview screen, tap **Custom**, and then select a name.

## Separating the exposure area and the focus area

If bright light affects the contrast or the subject is outside the auto focus area, use this feature to achieve an appropriate exposure. You can separate the exposure and focus areas and select the exposure level you want for the subject.



This feature is only available when you set the shutter speed and the focus to **Auto** in pro mode.

- 1 On the preview screen, tap and hold the area to focus.  
The AF/AE frame will appear on the focus area.

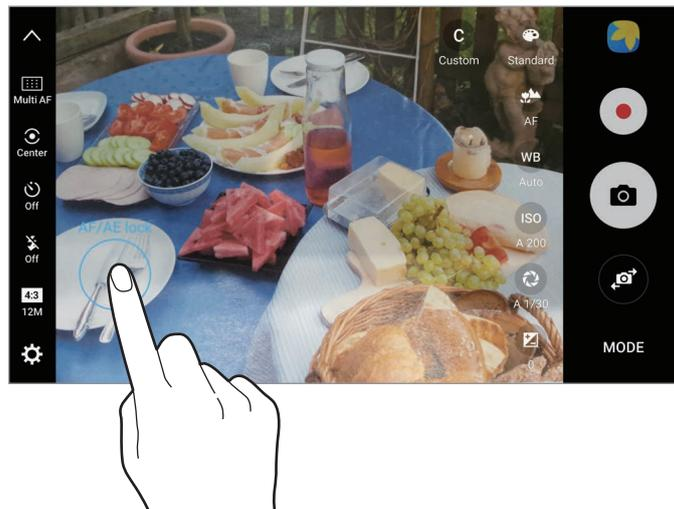

- 2 Drag the AF/AE frame to the exposure area.  
The exposure area will be separated from the focus area.



## Selective focus

Use the out-of-focus effect to make specific objects stand out in a photo.

- 1 On the preview screen, tap **MODE** → **Selective focus**.
- 2 Tap the image on the preview screen where the camera should focus.
- 3 Tap to take a photo.
- 4 Tap the preview thumbnail.
- 5 Tap and select one of the following:
  - **Near focus:** Make the subject stand out and blur the background around the subject.
  - **Far focus:** Blur the subject and make the background stand out around the subject.
  - **Pan focus:** Make the subject and its background stand out.

## 6 Tap **SAVE**.



- It is recommended that you position subjects within 50 cm of the device. Position the subject that you want to focus on close to the device.
- When taking photos, ensure there is sufficient distance between the subject and the background. The distance should be more than three times the distance between the device and the subject.
- Hold the device steady and remain still while taking a photo.
- The quality of photos taken by the device can be affected in the following conditions:
  - The device or the subject is moving.
  - There is strong background light, low levels of light, or you are taking photos indoors.
  - The subject or background has no pattern, or consists of a plain colour.

## Panorama

Take a series of photos horizontally or vertically and then stitch them together to create a wide scene.

On the preview screen, tap **MODE** → **Panorama**. To take a motion panorama, tap  → **On** to activate the motion panorama feature.



To get the best shots using panorama mode, follow these tips:

- Move the camera slowly in one direction.
- Keep the image within the frame on the camera's viewfinder. If the preview image is out of the guide frame or you do not move the device, the device will automatically stop taking photos.
- Avoid taking photos of indistinct backgrounds, such as an empty sky or a plain wall.
- When taking motion panoramas, sound will not be recorded.

## Viewing a motion panorama

View a motion panorama. You can view the photo from different angles by tilting the device or swiping on the screen.

- 1 On the preview screen, tap the preview thumbnail.
- 2 Tap .  
The captured motion panorama will be played.
- 3 Tilt the device or swipe on the screen to rotate the captured motion panorama.  
To save the motion panorama as a video file, tap **SAVE VIDEO**.

## Video Collage

Record videos to create a unique video collage. You can edit the videos and share them with others.

- 1 On the preview screen, tap **MODE** → **Video Collage**.
- 2 Tap  and select a collage type under the screen ratio you want to use.  
To record a video to view it in a slow motion video collage, select a collage type under **Slow motion collage**.



You can also select a recording time for videos. Tap  and select an option.

- 3 Tap  to start recording.  
After you record a video, an editing screen appears.

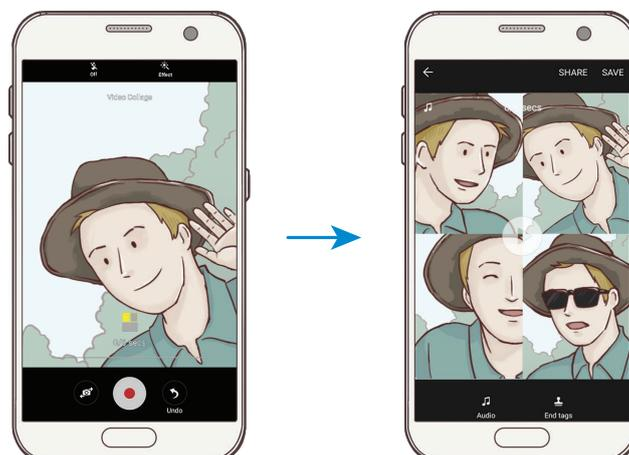

#### 4 Edit the video using the available options.

- **Audio:** Adjust the recorded sound or insert background music.
- **Slow parts:** Select sections of the video in each frame to be played in slow motion. This option appears when you select the Slow motion video option.
- **End tags:** Display the recording date and time on the video.

#### 5 When you are finished editing, tap **SAVE** to save the video.

To share the video with friends, tap **SHARE**.

## Live broadcast

Record and share live videos of your special moments. Invite your family and friends to watch your live broadcast. For more information about the YouTube broadcast feature, refer to YouTube's help menu.



- This feature may not be available depending on the region or service provider.
- You may incur additional charges for broadcasting via the mobile network.

## Before you start

- You must sign into your Google account to use this feature.
- To automatically save your broadcast on your device when it ends, open the preview screen, tap **Settings**, and then tap the **Auto save** switch to activate it. You can view your videos in **Gallery**.
- You can set the device to share your broadcast link via social network services while broadcasting. On the preview screen, tap **Settings** → **SNS settings** and tap the switch next to social network services you want to use.

## Starting your broadcast

- 1 On the preview screen, tap **MODE** → **Live broadcast**.
- 2 Read the terms and conditions, and then tap **CONFIRM**.
- 3 To change your channel's name, tap the default name and enter a new name.
- 4 To set your broadcast as public or private, tap **Settings** → **Privacy**.

- 5 Tap **Invite**, and select contacts or manually enter phone numbers.

When the broadcast starts, the video link will be sent to the selected contacts via message. The invited contacts can watch the broadcast by tapping the link.

- 6 Tap  to start broadcasting.

To invite more people during your broadcast, tap **Share** and select a sharing method. While inviting people, your broadcast will be paused. To start recording again, tap **RESUME**.



7 Tap  to end your broadcast.

The broadcast will be automatically uploaded to YouTube. To share the link with others, tap **SHARE LINK**.

You can create a shortcut to this feature on the Home screen by tapping **Settings** → **Add shortcut on home screen**.

## Watching a live broadcast

Invited contacts can watch the broadcast by tapping the video link they received. For public broadcasts, viewers can search for your channel name on YouTube.

## Slow motion

Record a video for viewing it in slow motion. You can specify sections of your videos to be played in slow motion.

1 On the preview screen, tap **MODE** → **Slow motion**.

2 Tap  to start recording.

3 When you are finished recording, tap  to stop.

4 On the preview screen, tap the preview thumbnail.

5 Tap .

The video will start playing with a randomly set slow motion section.

## Editing slow motion sections

- 1 On the preview screen, tap the preview thumbnail.
- 2 Tap .
 

The video will start playing with a randomly set slow motion section.
- 3 Tap  to pause playback.
- 4 Drag the start bracket and the end bracket to the desired points to set the duration of the video to be played.
- 5 Drag  to select the area of the video to be played in slow motion.
 

To set a slow motion section more precisely, tap and hold , and then drag your finger to the left or right to move through the section frame by frame.

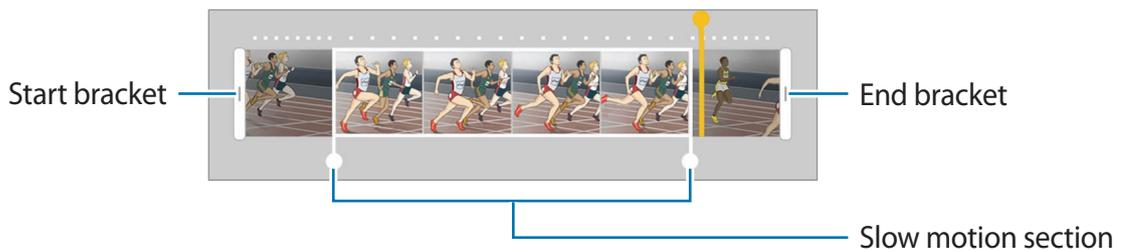

- 6 Tap the slow motion section and use the following options:
  - : Divide the section into two parts.
  - : Delete one of the divided section.
  - **1/8**: Change the playback speed of the selected section.
- 7 Tap  to preview the video.
- 8 Tap **EXPORT** to save the video.

## Virtual shot

Take a series of photos while circling a subject to create a view of the subject from multi angles. You can view the subject from different angles by dragging your finger left or right on the photo.

- 1 On the preview screen, tap **MODE** → **Virtual shot**.
- 2 Place a subject in the centre of the preview screen and tap .
- 3 Move the device around the subject slowly in one direction to take more photos.  
When the arrow becomes completely yellow or when you stop circling the subject, the device will automatically stop taking photos.

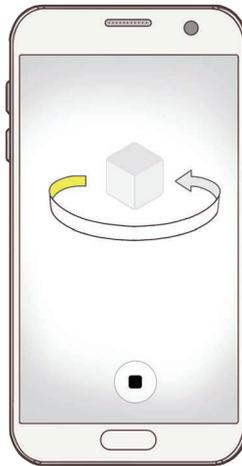

## Viewing virtual shot photos

- 1 On the preview screen, tap the preview thumbnail.
- 2 Tap .
- 3 Drag your finger left or right on the screen, or slowly swivel the device left or right to view the subject from different angles.

## Food

Take photos of food with more vibrant colours.

- 1 On the preview screen, tap **MODE** → **Food**.
- 2 Tap the screen and drag the circular frame over the area to highlight.  
The area outside the circular frame will be blurred.  
To resize the circular frame, drag a corner of the frame.



- 3 Tap  and drag the adjustment bar to adjust the colour tone.
- 4 Tap  to take a photo.

## Hyperlapse

Record scenes, such as passing people or cars, and view them as fast-motion videos. The frame rate is automatically adjusted to record smoother, less shaky fast-motion videos while walking, travelling by vehicle, and more.



In this mode, auto focusing will not operate.

- 1 On the preview screen, tap **MODE** → **Hyperlapse**.
- 2 Tap  and select a frame rate option.  
If you set the frame rate to **Auto**, the device will automatically adjust the frame rate according to the changing rate of the scene.
- 3 Tap  to start recording.
- 4 Tap  to finish recording.
- 5 On the preview screen, tap the preview thumbnail and tap  to view the video.

## Selfie

Take self-portraits with the front camera. You can preview various beauty effects on the screen.

- 1 On the preview screen, tap  to switch to the front camera for self-portraits.
- 2 Tap **MODE** → **Selfie**.

- 3 Face the front camera lens.
- 4 When the device detects your face, tap the sensor on the back of the device to take a photo of yourself.

Alternatively, show your palm to the front camera. After recognising your palm, a countdown timer will appear. When the time is up, the device will take a photo.

To use various shooting options for the front camera, tap  → **Shooting methods (front)**, and then tap the switches to activate them.

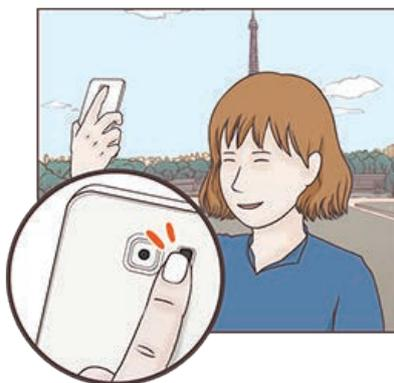

## Using the selfie flash

When taking self-portraits with the front camera in low-light situations, the touchscreen can serve as a flash.

On the preview screen, tap  repeatedly until you reach **On**. When you take a photo, the touchscreen will flash.

## Applying beauty effects

You can apply the spotlight effect or modify facial features, such as your skin tone or face shape, before taking self-portraits.



This feature is available only in **Selfie** mode.

- 1 On the preview screen, tap .
- 2 Select the options below to apply beauty effects to your face on the preview screen and take a photo of yourself.
  - **Skin tone:** Make your skin appear brighter and clearer.
  - **Spotlight:** Adjust the brightness and location of the spotlight. To set the location of the spot to highlight or to adjust the brightness, drag the adjustment bar towards the desired level.
  - **Slim Face:** Adjust the face shape and make your face appear slimmer.
  - **Large eyes:** Make your eyes appear bigger.
  - **Shape correction:** When your face is at the edges of the preview screen, it will appear distorted. Enable this option to correct your face shape. After shape correction, the background may appear slightly distorted.

## Wide selfie

Take a wide self-portrait to include more people in the photo and avoid leaving people out.

- 1 On the preview screen, tap  to switch to the front camera for self-portraits.
- 2 Tap **MODE** → **Wide selfie**.
- 3 Face the front camera lens.

- 4 When the device detects your face, tap the sensor on the back of the device to take a photo of yourself.

Alternatively, show your palm to the front camera. After recognising your palm, a countdown timer will appear. When the time is up, the device will take a photo.

To use various shooting options for the front camera, tap  → **Shooting methods (front)**, and then tap the switches to activate them.

- 5 Slowly swivel the device left and then right or vice versa to take a wide self-portrait.

The device will take additional photos when the white frame moves to each end of the viewfinder window.

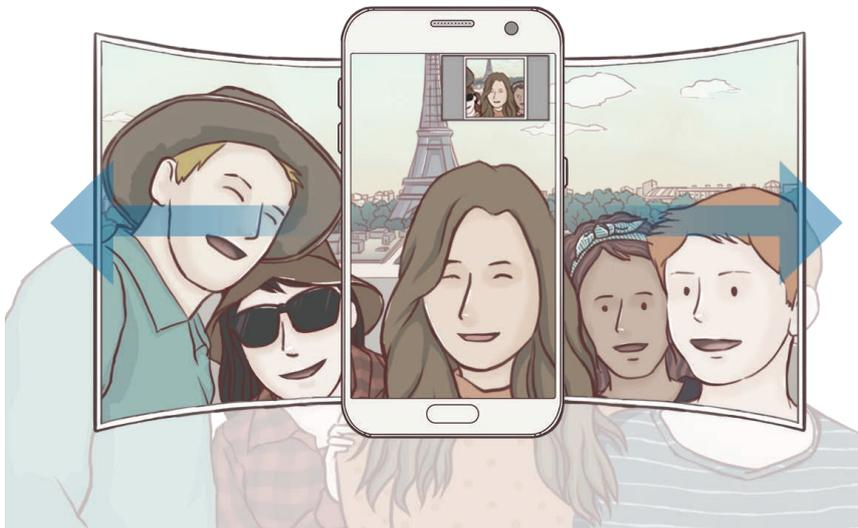

- Make sure to keep the white frame inside the viewfinder window.
- The subjects should remain still while taking wide self-portraits.
- The top and bottom parts of the image displayed on the preview screen may be cut out of the photo depending on the shooting conditions.

## Downloading modes

Download more shooting modes from **Galaxy Apps**.

On the preview screen, tap **MODE** → **DOWNLOAD**.



Some downloaded shooting modes do not have access to every feature.

## Camera settings

### Quick settings

On the preview screen, use the following quick settings.



The available options may vary depending on the shooting mode and which camera is being used.

-  : Select a filter effect to use when taking photos or recording videos. To set whether to display certain effects on the list or rearrange the order of effects, tap **Manager**. To download more effects, tap **Download**.
- **HDR** : Use this to take photos with rich colours and reproduce details, even in bright and dark areas.
-  : Change the focus area.  focuses on several areas within the frame. Multiple rectangles will appear to indicate the focused areas.  focuses on the centre within the frame.
-  : Select a metering method. This determines how light values are calculated. **Centre-weighted** uses the light in the centre portion of the shot to calculate the exposure of the shot. **Spot** uses the light in a concentrated centre area of the shot to calculate the exposure of the shot. **Matrix** averages the entire scene.
-  : Create motion panorama photos that can be played as videos. You can view the motion panorama photos at different angles by tilting the device or swiping on the screen.
-  : Select a video recording time.
-  : Change the video collage type or screen ratio. You can also record video collages featuring the slow motion effect.
-  : Select a frame rate.
-  : Select the length of the delay before the camera automatically takes a photo.
-  : Activate or deactivate the flash.

- **4:3**: Select a resolution for photos. Using a higher resolution will result in higher quality photos, but they will take up more memory.



The resolution of a photo may be affected by lighting conditions when taking photos with the front camera.

- : Adjust the colour tone.
- : Focus on a subject inside the circular frame and blur the image outside the frame.

## Camera settings

On the preview screen, tap .



The available options may vary depending on the shooting mode and which camera is being used.

- **Video size (rear) / Video size (front)**: Select a resolution for videos. Using a higher resolution will result in higher quality videos, but they will take up more memory.
- **Motion photo**: Set the device to take a video clip for a few seconds before tapping . This allows you to capture a moment you might have missed. To view the video, tap the preview thumbnail and tap . To capture a still image from the video clip, tap the screen to stop playback and tap **CAPTURE**.
- **Save pictures as previewed**: Invert the image to create a mirror-image of the original scene, when taking photos with the front camera.
- **Tracking AF**: Set the device to track and automatically focus on a selected subject. When you select a subject, the device will focus on the subject even if the subject is moving or you change the camera's position.



- When this feature is activated, you cannot use the Video stabilisation feature.
- Tracking a subject may fail in the following conditions:
  - The subject is too big or too small.
  - The subject moves excessively.
  - The subject is backlit or you are shooting in a dark place.
  - Colours or patterns on the subject and the background are the same.
  - The subject includes horizontal patterns, such as blinds.
  - The camera shakes excessively.
  - The video resolution is high.

- **Video stabilisation:** Activate anti-shake to reduce or eliminate blurry image resulting from camera shake while recording a video.
- **Grid lines:** Display viewfinder guides to help composition when selecting subjects.
- **Location tags:** Attach a GPS location tag to the photo.
  -  GPS signal strength may decrease in locations where the signal is obstructed, such as between buildings or in low-lying areas, or in poor weather conditions.
  - Your location may appear on your photos when you upload them to the Internet. To avoid this, deactivate the location tag setting.
- **Shooting methods (rear) / Shooting methods (front):** Select shooting options to use.
- **Review pictures:** Set the device to show photos after capturing them.
- **Quick launch:** Set the device to launch the camera by pressing the Home key twice quickly.
- **Save as RAW file:** Set the device to save photos as uncompressed RAW files (DNG file format) in pro mode. RAW files retain all of a photo's data for the best image quality, but they will take up more memory. To view RAW files, an image viewer app is required.
-  When using this feature, each photo is saved in two formats, DNG and JPG. Burst shot photos are only saved as JPG files.
  - You can view JPG files in **Gallery**. DNG files can be viewed or deleted in the **DCIM** → **Camera** folder.
- **Storage location:** Select the memory location for storage.
- **Volume keys function:** Set the device to use the Volume key to control the shutter or zoom function.
- **Reset settings:** Reset the camera settings.

# Gallery

## Introduction

View and manage photos and videos stored in the device.

## Viewing images

- 1 Tap **Gallery** on the Apps screen.
- 2 Select an image.

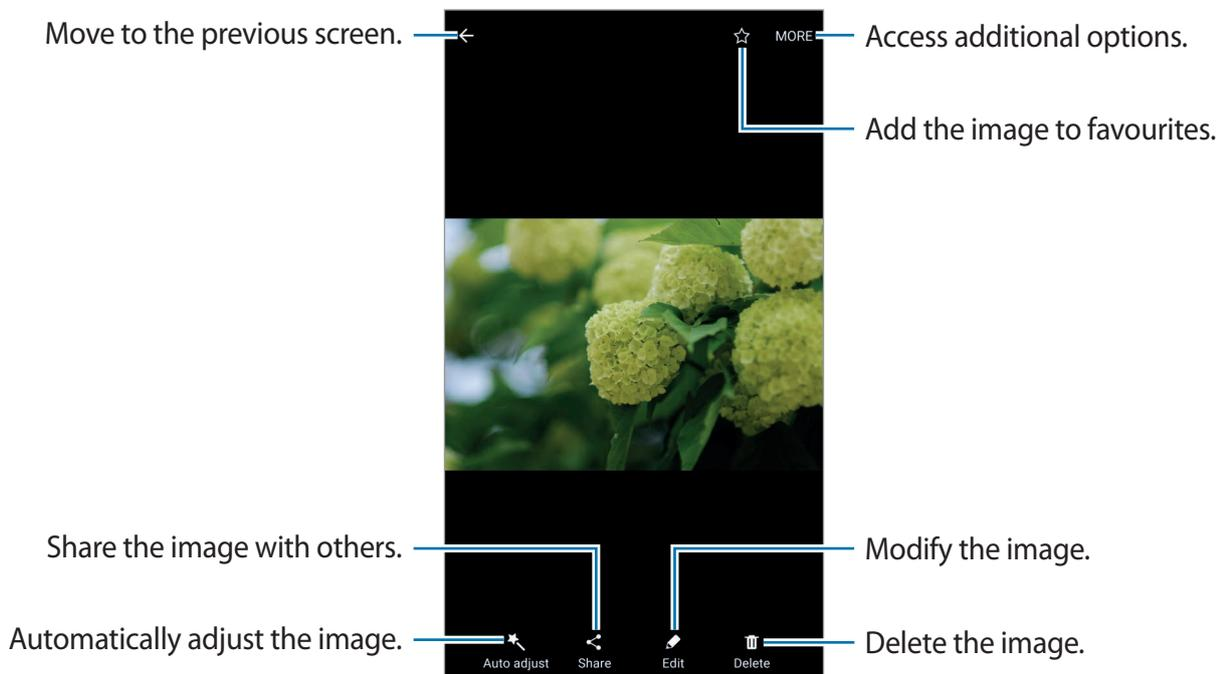

To hide or show the menus, tap the screen.

## Viewing videos

- 1 Tap **Gallery** on the Apps screen.
- 2 Select a video to play. Video files show the  icon on the preview thumbnail.

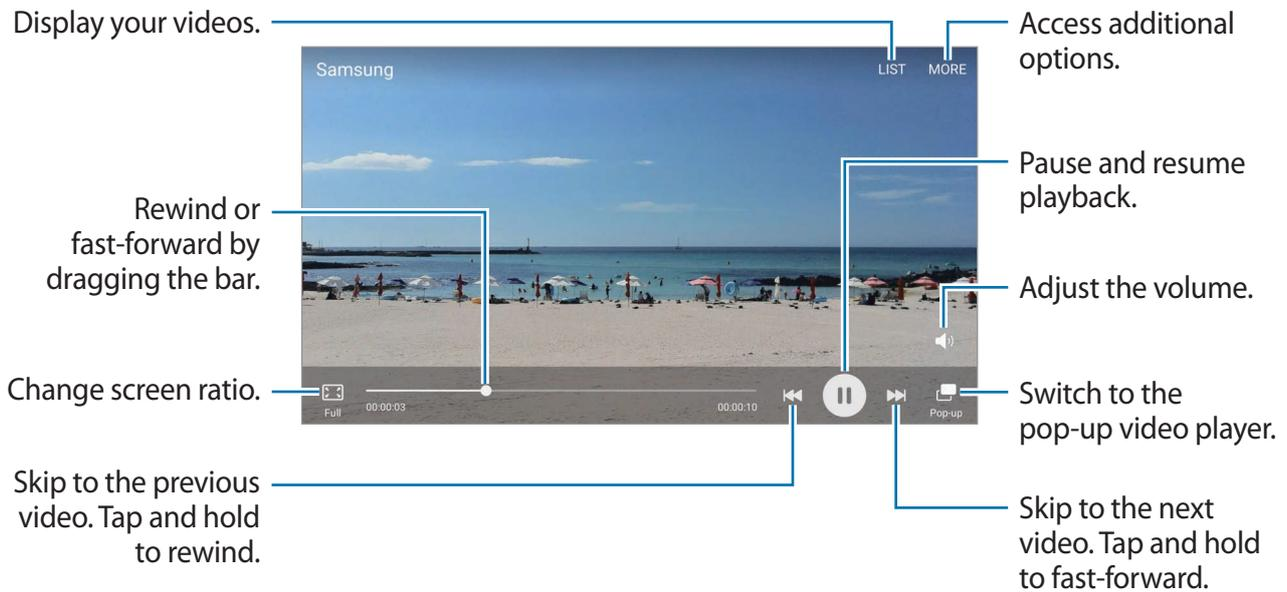

Drag your finger up or down on the left side of the playback screen to adjust the brightness, or drag your finger up or down on the right side of the playback screen to adjust the volume. To rewind or fast-forward, swipe to the left or right on the playback screen.

## Deleting images or videos

### Deleting an image or a video

Select an image or a video and tap **Delete** at the bottom of the screen.

## Deleting multiple images and videos

- 1 On the main Gallery screen, tap and hold an image or a video to delete.
- 2 Tick the images or videos to delete.
- 3 Tap **DELETE**.

## Sharing images or videos

Select an image or a video, tap **Share** at the bottom of the screen, and then select a sharing method.

## Sharing event albums

View photos and videos by time and location. You can share event albums with your contacts.

- 1 On the main Gallery screen, tap ▼ → **Event**.  
You can view photos and videos sorted by event.  
To manually create event albums, tap  and select photos or videos to add.

- 2 Select an event album to share.

- 3 Tap  and select contacts.

When your contacts accept the share request, the event album will be shared and more photos and videos can be added to the event album by your contacts.



- To use this feature, your phone number must be verified.
- You may incur additional charges when sharing files via the mobile network.
- If the recipients have not verified their phone numbers or if their devices do not support the feature, a link to the files will be sent to them via text message. Link recipients may not be able to use some features. The link will expire after a certain period.

# Samsung Pay

## Introduction

Register frequently used cards to Samsung Pay, a mobile payment service, to make payments quickly and securely. Samsung Pay supports magnetic secure transmission (MST) as well as near field communication (NFC) to allow payment through standard credit card readers.

You can view more information, such as cards that support this feature at [www.samsung.com/samsungpay](http://www.samsung.com/samsungpay). Alternatively, open the Apps screen and tap **Samsung Pay** → **More** → **Help**.



- This app's availability and supported features may vary depending on the region or service provider.
- The procedures for the initial setup and card registration may vary depending on the region or service provider.

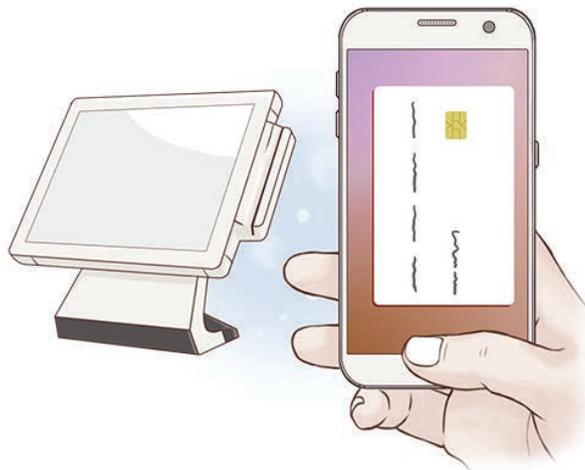

## Before you start

- To use this feature, you must sign in to your Samsung account and register your fingerprints. For more information, refer to [Samsung account](#) and [Fingerprint recognition](#).
- To make payments with Samsung Pay, the device may be required a connection to a Wi-Fi or mobile network depending on the region.

## Setting up Samsung Pay

When running this app for the first time or restart it after performing a data reset, follow the on-screen instructions to complete the initial setup.

- 1 On the Apps screen, tap **Samsung Pay**.
- 2 Sign in to your Samsung account.
- 3 Read and agree to the terms and conditions.
- 4 Register your fingerprint to use when making payments.
- 5 Create a PIN to use when making payments.



This PIN will be used to verify various actions in Samsung Pay, such as making payments and unlocking the app.

## Registering cards

You can easily register cards by capturing their images with the camera.



You can check the cards that support this feature from the Samsung Pay website ([www.samsung.com/samsungpay](http://www.samsung.com/samsungpay)).

On the Apps screen, tap **Samsung Pay** → **Add** and follow the on-screen instructions to complete your card registration.

## Making payments

- 1 Tap and hold a card image at the bottom of the screen and drag it upwards. Alternatively, tap **Samsung Pay** on the Apps screen.

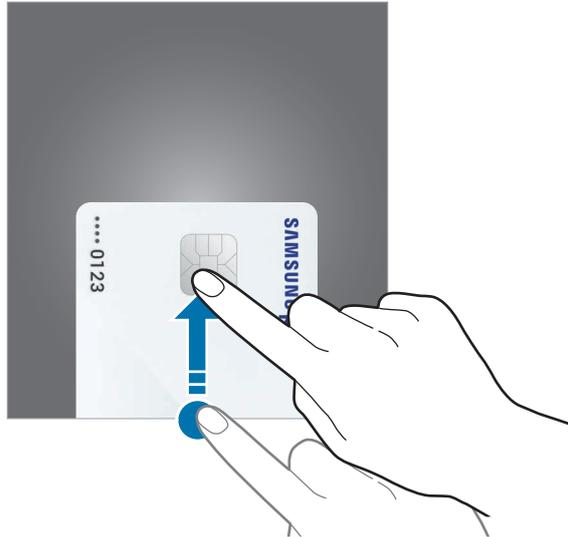

- 2 On the cards list, swipe to the left or right and select a card to use.

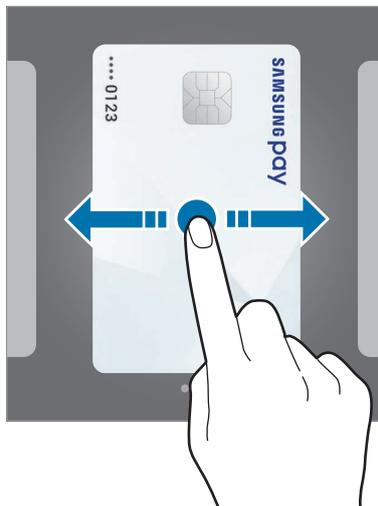

3 Place your finger on the Home key to scan your fingerprint.

Alternatively, enter the payment PIN you set when setting up the Samsung Pay.

4 Touch the back of your device to the card reader.

When the card reader recognises the card information, the payment will be processed.



Payments may not be processed depending on your network connection.

## Cancelling payments

You can cancel payments by visiting the place where you made them.

On the cards list, swipe to the left or right to select the card you used. Follow the on-screen instructions to complete payment cancellation.

## Changing the Samsung Pay settings

On the Samsung Pay screen, tap **More** → **Settings**. Select the screen where the card image will appear to activate Samsung Pay on the Home screen or locked screen, or when the screen is turned off.

## Samsung Gear

Samsung Gear is an app that allows you to manage your Gear wearable device. When you connect your device to the Gear, you can customise the Gear's settings and apps.

On the Apps screen, tap **Samsung Gear**.

Tap **CONNECT TO GEAR** to connect your device to the Gear. Follow the on-screen instructions to finish the setup. Refer to the Gear's user manual for more information about how to connect and use the Gear with your device.

# Game Launcher

## Introduction

Game Launcher gathers your games downloaded from **Play Store** and **Galaxy Apps** into one place for easy access. You can set the device to game mode to play games more easily.

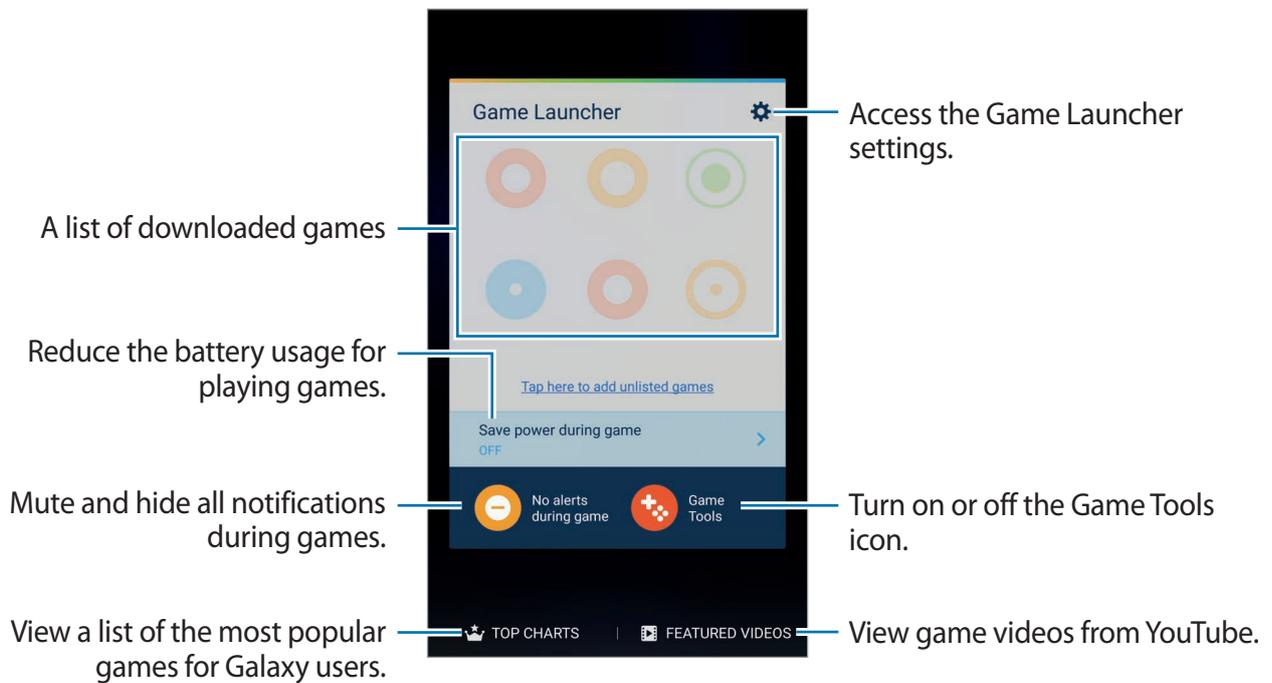

## Using Game Launcher

- 1 On the Apps screen, tap **Settings** → **Advanced features** → **Games** → **Game Launcher** and tap the switch to activate it.

**Game Launcher** will be added to the Home screen and the Apps screen.



When you deactivate the feature, **Game Launcher** will be removed from the Home screen and the Apps screen.

- 2 On the Apps screen, tap **Game Launcher**.

- 3 Tap a game from the games list.



Games downloaded from **Play Store** and **Galaxy Apps** will be automatically shown on the game launcher screen. If you cannot see your games, tap **Tap here to add unlisted games**.

## Removing a game from Game Launcher

Tap and hold a game and drag it to **Remove** at the top of the screen.

## Activating game power saving mode

When you activate game power saving mode, the device will lower games' resolution and frame rate to reduce battery consumption.

On the Apps screen, tap **Game Launcher** → **Save power during game**. Select one of the following options:

- **Off:** Power saving mode is not used.
- **Save power:** Decrease battery power consumption by lowering the resolution and frame rate.
- **Save maximum power:** Dramatically decrease the battery power consumption by lowering the resolution and frame rate.



Battery power efficiency may vary by game.

## Using Game Tools

You can set the Game Tools icon to be displayed as a floating icon on game screens.

On the Apps screen, tap **Settings** → **Advanced features** → **Games** → **Game Tools** and tap the switch to activate it.

While playing a game, tap  to display the game tools.

To move the icon, tap  and drag it to a new location.

To remove the icon from the current game screen, tap and hold  and drag it to **Remove** at the top of the screen.

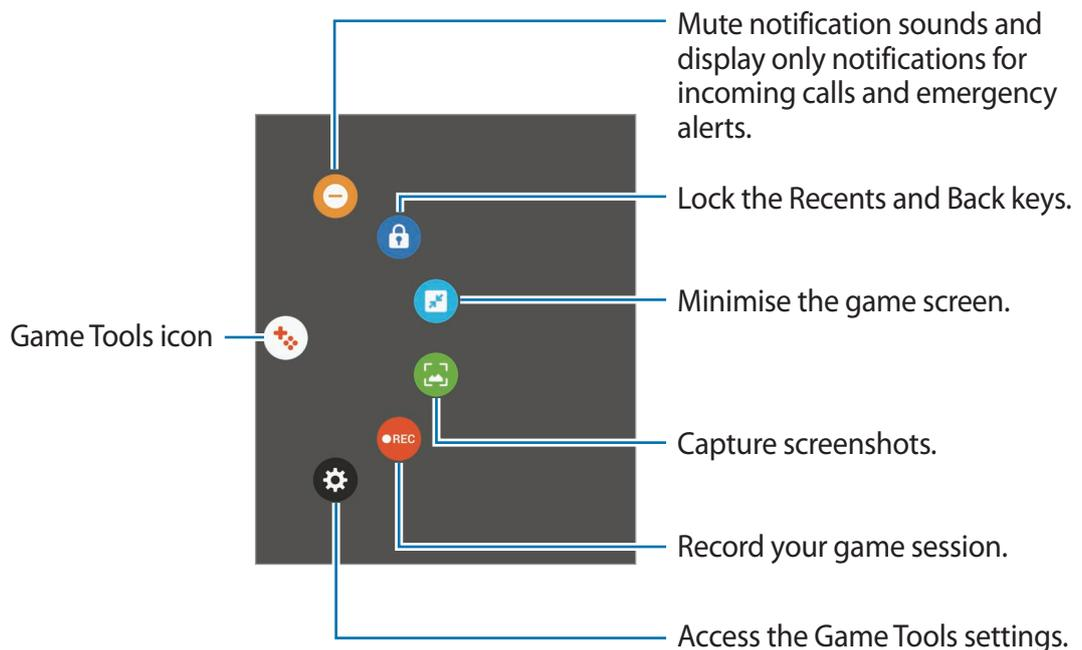

## Blocking notifications during games

Tap  →  to mute notification sounds and display only notifications for incoming calls and emergency alerts, so that you can enjoy your games without being disturbed. If you receive an incoming call, a small notification will appear at the top of the screen.

# S Planner

## Introduction

Manage your schedule by entering upcoming events or tasks in your planner.

## Creating events

- 1 Tap **S Planner** on the Apps screen.
- 2 Tap **+** or double-tap a date.  
If the date already has saved events or tasks in it, tap the date and tap **+**.
- 3 Enter event details.

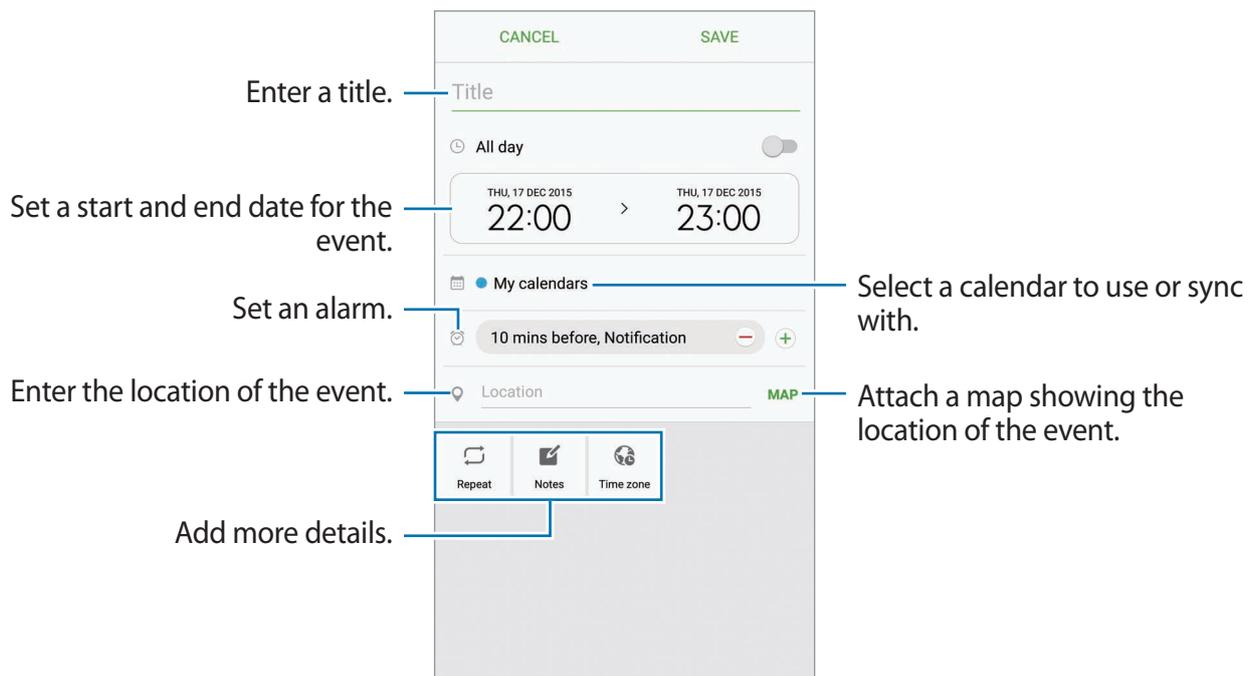

- 4 Tap **SAVE** to save the event.

## Creating tasks

- 1 Tap **S Planner** on the Apps screen.
- 2 Tap ▼ → **Tasks**.
- 3 Enter task details and tap **TODAY** or **TOMORROW** to set a due date.  
To add more details, tap .
- 4 Tap **SAVE** to save the task.

## Syncing events and tasks with your accounts

On the Apps screen, tap **Settings** → **Accounts**, select an account service, and then tap the **Sync Calendar** switch to sync events and tasks with the account.

To add accounts to sync with, open the Apps screen and tap **S Planner** → **MORE** → **Manage calendars** → **Add account**. Then, select an account to sync with and sign in. When an account is added, it will appear on the list.

# S Health

## Introduction

S Health helps you manage your wellness and fitness. Set fitness goals, check your progress, and keep track of your overall wellness and fitness.

## Starting S Health

When running this app for the first time or restart it after performing a data reset, follow the on-screen instructions to complete the setup.

- 1 Tap **Samsung** → **S Health** on the Apps screen.
- 2 Follow the on-screen instructions to complete the setup.

## Using S Health

You can view the key information from S Health menus and trackers to monitor your wellness and fitness.

Tap **Samsung** → **S Health** on the Apps screen.

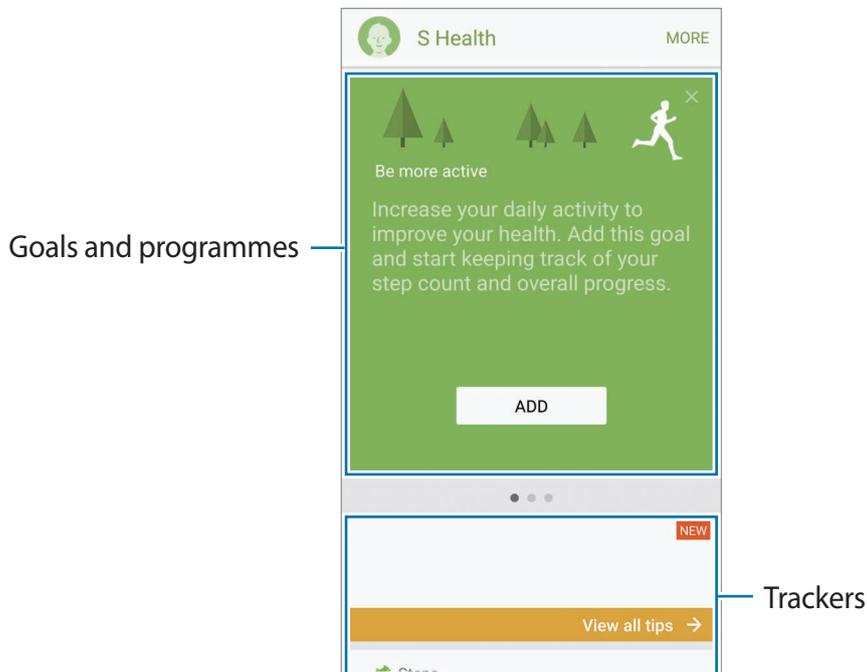

To add trackers, goals, or programmes to the S Health screen, tap **MORE** → **Manage items**, and then select items under the **TRACKERS**, **GOALS**, or **PROGRAMMES** tab.

- **GOALS:** Set your daily fitness goals and view your progress.
- **PROGRAMMES:** Use customisable exercise programmes.
- **TRACKERS:** Monitor your activities, food intake, and body measurements.



To access more information about S Health functions, tap **MORE** → **Settings** → **Help**.

## Additional information

- S Health is intended for fitness and wellness purposes only and is not intended for use in the diagnosis of disease or other conditions, or in the cure, mitigation, treatment, or prevention of disease.
- The available functions, features and addable applications for S Health may vary from country to country due to different local laws and regulations. You should check the features and applications available in your specific region before use.
- S Health applications and its service can be changed or discontinued without prior notice.
- The purpose for data collection is limited to providing the service that you have requested, including providing additional information to enhance your wellness, sync data, data analysis and statistics or to develop and provide better services. (But if you sign in to your Samsung account from S Health, your data may be saved on the server for data backup purposes.) Personal information may be stored until the completion of such purposes. You can delete personal data stored by S Health by using the Reset data option in the Settings menu. To delete any data you have shared with social networks or transferred to storage devices, you must delete them separately.
- You may share and/or sync your data with additional Samsung services or compatible third party services that you select, as well as with any of your other connected devices. Access to S Health information by such additional services or third party devices will only be permitted with your express approval.
- You assume full responsibility for the inappropriate use of data shared on social networks or transmitted to others. Use caution when sharing your personal data with others.
- If the device is connected to measuring devices, verify the communication protocol to confirm proper operation. If you use a wireless connection, such as Bluetooth, the device may be affected by electronic interference from other devices. Avoid using the device near other devices that transmit radio waves.
- Please read Terms and Conditions and Privacy Policy of S Health carefully before using it.

# S Voice

## Introduction

Perform various tasks simply by speaking.

## Setting a wake-up command

You can launch **S Voice** using your own wake-up command.

When launching **S Voice** for the first time, tap **START** and set your own wake-up command.

To change the wake-up command, open the Apps screen and tap **S Voice**. Then, tap  → **Voice wake-up** → **Change wake-up command** → **START**, and then follow the on-screen instructions.

To set the device to launch **S Voice** using the wake-up command while the device is locked, tap  and tap the **Wake up in secured lock** switch to activate it.

## Using S Voice

1 Say the preset wake-up command.

Alternatively, on the Apps screen, tap **Samsung** → **S Voice**.

When **S Voice** is launched, the device begins voice recognition.



This app may not be available depending on the region or service provider.

S Voice settings



View examples of voice commands.

## 2 Say a voice command.

If the device recognises the command, the device will perform the corresponding action. To repeat a voice command or say a different command, tap  or say the preset wake-up command.



This app will close automatically if the device is not used for a specified period.

## Tips for better voice recognition

- Speak clearly.
- Speak in quiet places.
- Do not use offensive or slang words.
- Avoid speaking in dialectal accents.

The device may not recognise your commands or may perform unwanted commands depending on your surroundings or how you speak.

## Setting the language

On the Apps screen, tap **Samsung** → **S Voice** →  → **Language**, and then select a language.



The selected language is applied to **S Voice** only, not to the language displayed on the device.

# Voice Recorder

## Introduction

Use different recording modes for various situations, such as in an interview. The device can convert your voice to text and distinguish between sound sources.

## Making voice recordings

- 1 On the Apps screen, tap **Samsung** → **Voice Recorder**.
- 2 Tap  to start recording. Speak into the microphone.  
Tap  to pause recording.  
While making a voice recording, tap **BOOKMARK** to insert a bookmark.

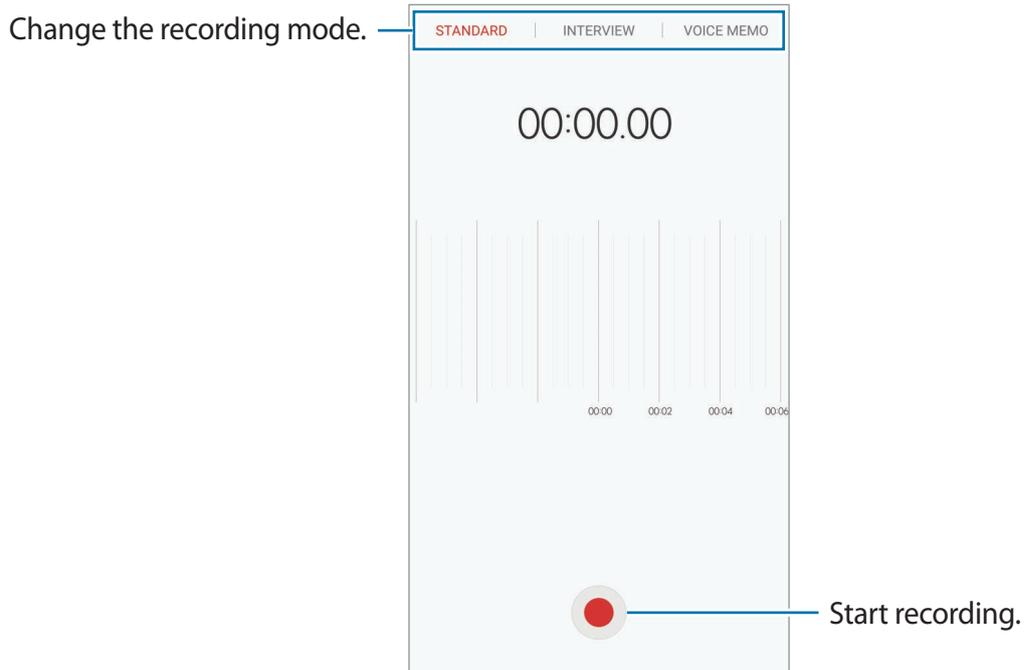

- 3 Tap **SAVE** to finish recording.

## Changing the recording mode

On the Apps screen, tap **Samsung** → **Voice Recorder**.

Select a mode from the top of the voice recorder screen.

- **STANDARD:** This is the normal recording mode.
- **INTERVIEW:** The microphone is sensitive to sounds from two directions. In this mode, both the top and the bottom of the device pick up equal amounts of sound.
- **VOICE MEMO:** The device records your voice and simultaneously converts it to on-screen text. For best results, keep the device near your mouth and speak loudly and clearly in a quiet place.



If the voice memo system language does not match the language you are speaking, the device will not recognise your voice. Before using this feature, tap the current language to set the voice memo system language.

## Playing selected voice recordings

When you review interview recordings, you can mute or unmute certain sound sources in the recording.

- 1 On the Apps screen, tap **Samsung** → **Voice Recorder**.
- 2 Tap **Recordings** and select a voice recording made in interview mode.
- 3 To mute certain sound sources, tap  for the corresponding direction that sound is to be muted.

The icon will change to  and the sound will be muted.

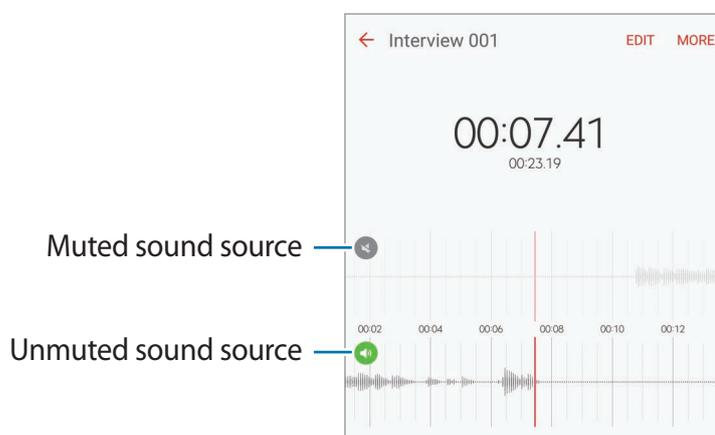

## My Files

Access and manage various files stored in the device or in other locations, such as cloud storage services.

On the Apps screen, tap **Samsung** → **My Files**.

View files by category or view files stored in the device or a cloud storage service.

To check the status of used and available memory, tap **STORAGE USAGE**.

To search for files or folders, tap **SEARCH**.

## Memo

Create memos and organise them by category.

On the Apps screen, tap **Memo**.

### Composing memos

Tap  on the memos list and enter a memo. While composing a memo, use the following options:

- **Category:** Create or set a category.
- **Tasks:** Add tick boxes at the beginning of each row to create a list of tasks.
- **Image:** Insert images.
- **Drawing:** Write or draw memos to insert. You can select pen thickness and colour.
- **Voice:** Make a voice recording to insert.

To save the memo, tap **SAVE**.

To edit a memo, tap a memo, and then tap the content of the memo.

### Searching for memos

Tap **SEARCH** on the memos list and enter a keyword to search for memos that include the keyword.

# Clock

## Introduction

Set alarms, check the current time in many cities around the world, time an event, or set a specific duration.

## Alarm

On the Apps screen, tap **Clock** → **Alarm**.

### Setting alarms

Set an alarm time and tap **SAVE**.

To open the keypad to enter an alarm time, tap the time input field.

To set an alarm with various alarm options, tap **OPTIONS**, set alarm options, and then tap **SAVE**.

To activate or deactivate alarms, tap the clock icon next to the alarm in the alarms list.

### Stopping alarms

Tap **DISMISS** to stop an alarm. If you have previously enabled the snooze option, tap **SNOOZE** to repeat the alarm after a specified length of time.

### Deleting alarms

Tap ✕ on an alarm in the list of alarms.

## World clock

On the Apps screen, tap **Clock** → **World clock**.

### Creating clocks

Enter a city name or select a city from the globe, and then tap +.

### Deleting clocks

Tap ✕ on a clock.

## Stopwatch

- 1 On the Apps screen, tap **Clock** → **Stopwatch**.
- 2 Tap **START** to time an event.  
To record lap times while timing an event, tap **LAP**.
- 3 Tap **STOP** to stop timing.  
To restart the timing, tap **RESUME**.  
To clear lap times, tap **RESET**.

## Timer

- 1 On the Apps screen, tap **Clock** → **Timer**.
- 2 Set the duration, and then tap **START**.  
To open the keypad to enter the duration, tap the duration input field.
- 3 Tap **DISMISS** when the timer goes off.

## Calculator

Perform simple or complex calculations.

Tap **Calculator** on the Apps screen.

Rotate the device to landscape orientation to display the scientific calculator. If **Auto rotate** is disabled, tap  to display the scientific calculator.

To see the calculation history, tap **HISTORY**. To close the calculation history panel, tap **KEYPAD**.

To clear the history, tap **HISTORY** → **CLEAR HISTORY**.

## Google apps

Google provides entertainment, social network, and business apps. You may require a Google account to access some apps. Refer to [Accounts](#) for more information.

To view more app information, access each app's help menu.



Some apps may not be available or may be labelled differently depending on the region or service provider.

### Chrome

Search for information and browse webpages.

### Gmail

Send or receive emails via the Google Mail service.

### Maps

Find your location on the map, search for locations, and view location information for various places.

### Play Music

Discover, listen to, and share music on your device. You can upload music collections stored on your device to the cloud and access them later.

### Play Movies & TV

Download videos to watch from **Play Store**.

### Drive

Store your content on the cloud, access it from anywhere, and share it with others.

### YouTube

Watch or create videos and share them with others.

## **Photos**

Search for, manage, and edit all your photos and videos from various sources in one place.

## **Hangouts**

Chat with your friends individually or in groups and use images, emoticons, and video calls while you are chatting.

## **Google**

Search quickly for items on the Internet or your device.

# Settings

## Introduction

Customise settings for functions and apps. You can make your device more personalised by configuring various setting options.

On the Apps screen, tap **Settings**.

To search for settings by entering keywords, tap **SEARCH**.

To edit the list of frequently used settings, tap **EDIT**. Then, tick items to add or deselect items to remove.

## Wi-Fi

### Connecting to a Wi-Fi network

Activate the Wi-Fi feature to connect to a Wi-Fi network and access the Internet or other network devices.



- Your device uses a non-harmonised frequency and is intended for use in all European countries. The WLAN can be operated in the EU without restriction indoors, but cannot be operated outdoors.
- Turn off Wi-Fi to save the battery when not in use.

**1** On the Settings screen, tap **Wi-Fi**, and then tap the switch to activate it.

**2** Select a network from the Wi-Fi networks list.

Networks that require a password appear with a lock icon.

### 3 Tap **CONNECT**.



- Once the device connects to a Wi-Fi network, the device will reconnect to that network each time it is available without requiring a password. To prevent the device connecting to the network automatically, select it from the list of networks and tap **FORGET**.
- If you cannot connect to a Wi-Fi network properly, restart your device's Wi-Fi feature or the wireless router.

## Wi-Fi Direct

Wi-Fi Direct connects devices directly via a Wi-Fi network without requiring an access point.

1 On the Settings screen, tap **Wi-Fi**, and then tap the switch to activate it.

2 Tap **Wi-Fi Direct**.

The detected devices are listed.

If the device you want to connect to is not in the list, request that the device turns on its Wi-Fi Direct feature.

3 Select a device to connect to.

The devices will be connected when the other device accepts the Wi-Fi Direct connections request.

## Sending and receiving data

You can share data, such as contacts or media files, with other devices. The following actions are an example of sending an image to another device.

1 Tap **Gallery** on the Apps screen.

2 Select an image.

3 Tap **Share** → **Wi-Fi Direct** and select a device to transfer the image to.

4 Accept the Wi-Fi Direct connection request on the other device.

If the devices are already connected, the image will be sent to the other device without the connection request procedure.

## Ending the device connection

1 Tap **Wi-Fi** on the Settings screen.

2 Tap **Wi-Fi Direct**.

The device displays the connected devices in the list.

3 Tap the device name to disconnect the devices.

# Bluetooth

## Introduction

Use Bluetooth to exchange data or media files with other Bluetooth-enabled devices.



- Samsung is not responsible for the loss, interception, or misuse of data sent or received via Bluetooth.
- Always ensure that you share and receive data with devices that are trusted and properly secured. If there are obstacles between the devices, the operating distance may be reduced.
- Some devices, especially those that are not tested or approved by the Bluetooth SIG, may be incompatible with your device.
- Do not use the Bluetooth feature for illegal purposes (for example, pirating copies of files or illegally tapping communications for commercial purposes).

Samsung is not responsible for the repercussion of illegal use of the Bluetooth feature.

## Pairing with other Bluetooth devices

1 On the Settings screen, tap **Bluetooth**, and then tap the switch to activate it.  
The detected devices are listed.

2 Select a device to pair with.

If the device you want to pair with is not in the list, request that the device turns on its visibility option. Refer to the other device's user manuals.



Your device is visible to other devices while the Bluetooth settings screen is open.

3 Accept the Bluetooth connection request on your device to confirm.

The devices will be connected when the other device accepts the Bluetooth connection request.

## Sending and receiving data

Many apps support data transfer via Bluetooth. You can share data, such as contacts or media files, with other Bluetooth devices. The following actions are an example of sending an image to another device.

1 Tap **Gallery** on the Apps screen.

2 Select an image.

3 Tap **Share** → **Bluetooth**, and then select a device to transfer the image to.

If your device has paired with the device before, tap the device name without confirming the auto-generated passkey.

If the device you want to pair with is not in the list, request that the device turns on its visibility option.

4 Accept the Bluetooth connection request on the other device.

## Unpairing Bluetooth devices

- 1 Tap **Bluetooth** on the Settings screen.  
The device displays the paired devices in the list.
- 2 Tap  next to the device name to unpair.
- 3 Tap **Unpair**.

## Flight mode

This disables all wireless functions on your device. You can use only non-network services.

On the Settings screen, tap **Flight mode**.



Make sure the device is turned off during takeoff and landing. After takeoff, you can use the device in flight mode if allowed by aircraft personnel.

## Mobile hotspot and tethering

Use the device as a mobile hotspot to share the device's mobile data connection with other devices when the network connection is not available. Connections can be made via Wi-Fi, USB, or Bluetooth.

On the Settings screen, tap **Mobile hotspot and tethering**.



You may incur additional charges when using this feature.

- **Mobile hotspot:** Use the mobile hotspot to share the device's mobile data connection with computers or other devices.
- **Bluetooth tethering:** Use Bluetooth tethering to share the device's mobile data connection with computers or other devices via Bluetooth.
- **USB tethering:** Use USB tethering to share the device's mobile data connection with a computer via USB. When connected to a computer, the device is used as a wireless modem for the computer.

## Using the mobile hotspot

Use your device as a mobile hotspot to share your device's mobile data connection with other devices.

- 1 On the Settings screen, tap **Mobile hotspot and tethering** → **Mobile hotspot**.
- 2 Tap the switch to activate it.  
The  icon appears on the status bar. Other devices can find your device in the Wi-Fi networks list.  
To set a password for the mobile hotspot, tap **MORE** → **Configure Mobile hotspot** and select the level of security. Then, enter a password and tap **SAVE**.
- 3 On the other device's screen, search for and select your device from the Wi-Fi networks list.
- 4 On the connected device, use the device's mobile data connection to access the Internet.

## Data usage

Keep track of your data usage amount and customise the settings for the limitation.

On the Settings screen, tap **Data usage**.

- **Mobile data:** Set the device to use data connections on any mobile network.
- **Background data:** Prevent apps that are running in the background from using a mobile data connection.
- **Set mobile data limit:** Set a limit for mobile data usage.

To change the monthly reset date for the monitoring period, tap ▼ → **Change cycle**.

## Limiting data usage

Set the device to automatically disable the mobile data connection when the amount of mobile data you have used reaches your specified limit.

- 1 On the Settings screen, tap **Data usage** and tap the **Set mobile data limit** switch to activate it.
- 2 Drag the limit adjustment bar upwards or downwards to set the limit.
- 3 Drag the warning adjustment bar upwards or downwards to set a data usage alert level. The device will alert you when the warning level is reached.

## SIM card manager (dual SIM models)

Activate your SIM or USIM cards and customise the SIM card settings. Refer to [Using dual SIM or USIM cards \(dual SIM models\)](#) for more information.

On the Settings screen, tap **SIM card manager**.

- **Voice call:** Select a SIM or USIM card for voice calls.
- **Text messages:** Select a SIM or USIM for messaging.
- **Mobile data:** Select a SIM or USIM card for data service.
- **Dual SIM always on:** Set the device to allow incoming calls from the other SIM or USIM card during a call.



When this feature is enabled, you may incur additional charges for call forwarding depending on the region or service provider.

## Mobile networks

Configure your mobile network settings.

On the Settings screen, tap **Mobile networks**.

- **Data roaming:** Set the device to use data connections when you are roaming.
- **Access Point Names:** Set up access point names (APNs).
- **Network mode** (single SIM models): Select a network type.  
**Network mode SIM 1 / Network mode SIM 2** (dual SIM models): Select a network type.
- **Network operators:** Search for available networks and manually register a network.

## NFC and payment

### Introduction

Your device allows you to read near field communication (NFC) tags that contain information about products. You can also use this feature to make payments and buy tickets for transportation or events after downloading the required apps.



The device contains a built-in NFC antenna. Handle the device carefully to avoid damaging the NFC antenna.

### Using the NFC feature

Use the NFC feature to send images or contacts to other devices, and read product information from NFC tags.

- 1 On the Settings screen, tap **NFC and payment**, and then tap the switch to activate it.

- 2 Place the NFC antenna area on the back of your device near an NFC tag.  
The information from the tag appears.

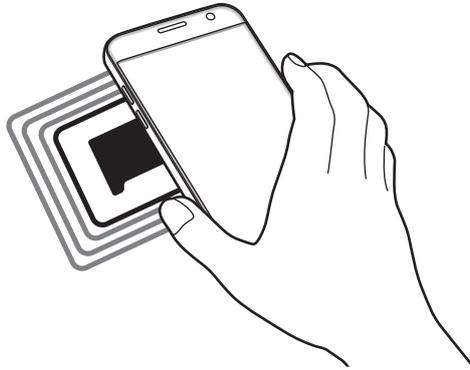

Ensure that the device's screen is unlocked. Otherwise, the device will not read NFC tags or receive data.

## Making payments with the NFC feature

Before you can use the NFC feature to make payments, you must register for the mobile payment service. To register or get more information about the service, contact your service provider.

- 1 On the Settings screen, tap **NFC and payment**, and then tap the switch to activate it.
- 2 Touch the NFC antenna area on the back of your device to the NFC card reader.

To set the default payment app, open the Settings screen and tap **NFC and payment** → **Tap and pay** → **PAYMENT**, and then select an app.



The payment services list may not include all available payment apps.

## Sending data

Allow data exchange when your device's NFC antenna touches the other device's NFC antenna.

- 1 On the Settings screen, tap **NFC and payment**, and then tap the switch to activate it.
- 2 Tap **Android Beam** and tap the switch to activate it.
- 3 Select an item and touch the other device's NFC antenna to your device's NFC antenna.
- 4 When **Touch to beam.** appears on the screen, tap your device's screen to send the item.



If both devices try to send data simultaneously, the file transfer may fail.

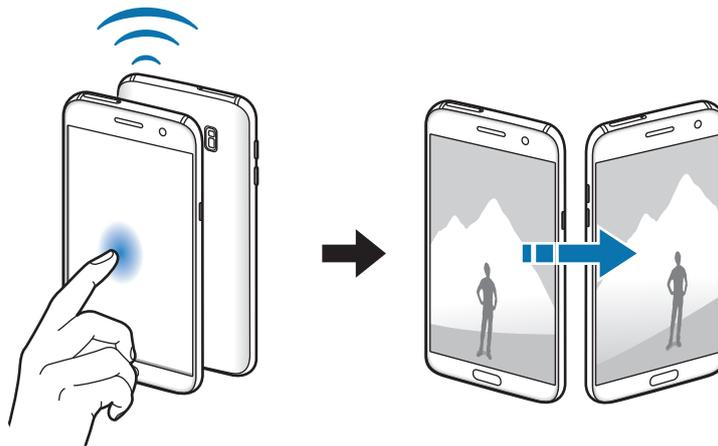

# More connection settings

## Options

Customise settings to control other features.

On the Settings screen, tap **More connection settings**.

- **Nearby device scanning:** Set the device to scan for nearby devices to connect to.
- **Printing:** Configure settings for printer plug-ins installed on the device. You can search for available printers or add one manually to print files. Refer to [Printing](#) for more information.
- **MirrorLink:** Use the MirrorLink feature to control your device's MirrorLink apps on the vehicle's head unit monitor. Refer to [MirrorLink](#) for more information.
- **Download booster:** Set the device to download files larger than 30 MB, faster via Wi-Fi and mobile networks simultaneously. Refer to [Download booster](#) for more information.
- **VPN:** Set up and connect to virtual private networks (VPNs).

## Printing

Configure settings for printer plug-ins installed on the device. You can connect the device to a printer via Wi-Fi or Wi-Fi Direct, and print images or documents.



Some printers may not be compatible with the device.

## Adding printer plug-ins

Add printer plug-ins for printers you want to connect the device to.

- 1 On the Settings screen, tap **More connection settings** → **Printing** → **Download plug-in**.
- 2 Search for a printer plug-in in **Play Store**.

3 Select a printer plug-in and install it.

4 Select the printer plug-in and tap the switch to activate it.

The device searches for printers that are connected to the same Wi-Fi network as your device.

To add printers manually, tap **MORE** → **Add printer** → **ADD PRINTER**.

To change print settings, tap **MORE** → **Printing settings**.

## Printing content

While viewing content, such as images or documents, tap **Share** → **Print** → ▼ → **All printers**, and then select a printer.

## MirrorLink

Connect your device to a vehicle to control your device's MirrorLink apps on the vehicle's head unit monitor.

On the Settings screen, tap **More connection settings** → **MirrorLink**.



Your device is compatible with vehicles that support MirrorLink version 1.1 or higher.

## Connecting your device to a vehicle via MirrorLink

When using this feature for the first time, connect the device to a Wi-Fi or mobile network.

1 Pair your device with a vehicle via Bluetooth.

Refer to [Pairing with other Bluetooth devices](#) for more information.

2 Connect your device to the vehicle using a USB cable.

When they are connected, access your device's MirrorLink apps on the head unit monitor.

## Ending the MirrorLink connection

Unplug the USB cable from your device and the vehicle.

## Download booster

Set the device to download files larger than 30 MB, faster via Wi-Fi and mobile networks simultaneously. A stronger Wi-Fi signal will provide a faster download speed.

On the Settings screen, tap **More connection settings** → **Download booster**.



- This feature may not be supported by some devices.
- You may incur additional charges when downloading files via the mobile network.
- When you download large files, the device may heat up. If the device exceeds a set temperature, the feature will turn off.
- If network signals are unstable, the speed and performance of this feature may be affected.
- If the Wi-Fi and mobile network connections have significantly different data transfer speeds, the device may use only the fastest connection.
- This feature supports Hypertext Transmission Protocol (HTTP) 1.1 and Hypertext Transmission Protocol Secure (HTTPS). The feature cannot be used with other protocols, such as FTP.

## Smart Manager

### Introduction

The Smart manager provides an overview of the status of your device's battery, storage, RAM, and system security. You can also automatically optimise the device with a tap of your finger.

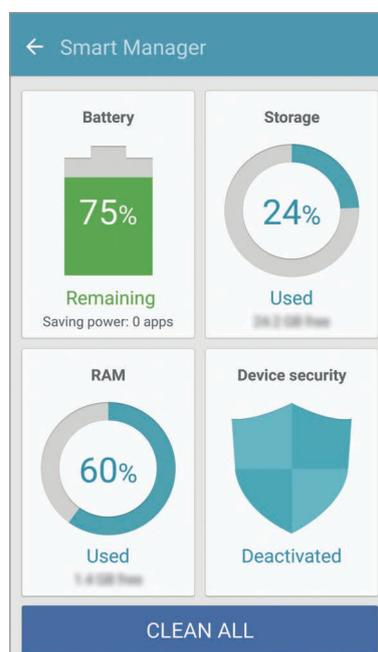

## Using the quick optimisation feature

On the Settings screen, tap **Smart Manager** → **CLEAN ALL**.

The quick optimisation feature improves device performance through the following actions.

- Clearing some memory.
- Deleting unnecessary files and closing apps running in the background.
- Scanning for malware.

## Battery

On the Settings screen, tap **Smart Manager** → **Battery**.

Check the remaining battery power and time to use the device. For devices with low battery levels, conserve battery power by activating power saving features.



- The usage time left shows the time remaining before the battery power runs out. Usage time left may vary depending on your device settings and operating conditions.
- You cannot receive notifications from apps that use power saving mode.

## Managing the battery

To save battery power by setting whether to optimise the battery usage for each app, tap **DETAILS** for the app power saving and tap the **App power saving** switch to activate it.

You can set the device to charge the battery more quickly. Tap the **Fast cable charging** switch to activate it.

## Storage

Check the status of the used and available memory.

On the Settings screen, tap **Smart Manager** → **Storage**.

### Managing the memory

To delete residual files, such as cache, tap **DELETE**. To delete files or uninstall apps that you do not use any more, tap **DETAILS** for the user data and select a category. Then, tick items to select and tap **DELETE**.

## RAM

On the Settings screen, tap **Smart Manager** → **RAM**.

To speed up your device by reducing the amount of RAM you are using, tap **END ALL** to close all background apps.

## Device security

Check the device's security status. This feature scans your device for malware.

On the Settings screen, tap **Smart Manager** → **Device security**.

## Applications

Manage the device's apps and change their settings.

On the Settings screen, tap **Applications**.

- **Application manager:** View and manage the apps on your device.
- **Default applications:** Select a default setting for using apps.
- **Application settings:** Customise the settings for each app.
- **Google settings:** Configure settings for some features provided by Google.

## Sounds and vibration

Change settings for various sounds on the device.

On the Settings screen, tap **Sounds and vibration**.

- **Sound mode:** Set the device to use sound mode or silent mode.
- **Vibrate while ringing:** Set the device to vibrate and play a ringtone for incoming calls.
- **Volume:** Adjust the volume level for call ringtones, music and videos, system sounds, and notifications.
- **Vibration intensity:** Adjust the force of the vibration notification.
- **Ringtone:** Change the ringtone settings.
- **Vibration pattern:** Select a vibration pattern.
- **Notification sounds:** Select a default notification sound. You can also change the notification settings for each app.
- **Touch sounds:** Set the device to sound when you select an app or option on the touchscreen.
- **Screen lock sounds:** Set the device to sound when you lock or unlock the touchscreen.
- **Charging sounds:** Set the device to sound when it is connected to a charger.
- **Vibration feedback:** Set the device to vibrate when you tap  or  and for other actions, such as tapping and holding items.
- **Dialling keypad tone:** Set the device to sound when you tap the buttons on the keypad.
- **Keyboard sound:** Set the device to sound when a key is touched.
- **Keyboard vibration:** Set the device to vibrate when a key is touched.
- **Sound quality and effects:** Configure additional sound settings.

## Notifications

Change the notification settings for each app.

On the Settings screen, tap **Notifications**.

To customise notification settings, tap **ADVANCED** and select an app.

- **Allow notifications:** Allow notifications from the selected app.
- **Set as priority:** Display notifications at the top of the notification panel and include them in the allowed list when **Do not disturb** is activated.
- **Previews in pop-ups:** Display notification previews in pop-up windows.
- **Hide on lock screen:** Hide notifications from the selected app when the device is locked.
- **Hide content on lock screen:** Hide the content of notifications from the selected app when the device is locked.
- **More settings:** Customise additional notification settings for the selected app.

## Do not disturb

Set the device to mute incoming calls and notification sounds, except for allowed exceptions.

On the Settings screen, tap **Do not disturb**.

- **Enable now:** Activate Do not disturb mode immediately.
- **Enable as scheduled:** Activate Do not disturb mode at preset times. You can select days and set the start and end times.
- **Allow exceptions:** Customise the settings for allowed exceptions.

# Display

## Options

Change the display settings.

On the Settings screen, tap **Display**.

- **Brightness:** Adjust the brightness of the display.
- **Font:** Change the font size and type.
- **Icon backgrounds:** Set whether to display shaded backgrounds to make icons stand out.
- **Screen timeout:** Set the length of time the device waits before turning off the display's backlight.
- **Smart stay:** Set the device to prevent the display backlight from turning off while you are looking at the display.
- **Always on display:** Set the device to display an image or information while the screen is turned off. Refer to [Always on display](#) for more information.
- **Screen mode:** Change the screen mode to adjust the display's colour and contrast.
- **LED indicator:** Set the device to turn on the LED indicator while the battery is charging, when you have notifications, or when you make voice recordings.
- **Keep screen turned off:** Set the device to prevent the screen from turning on when it is in a dark place, such as a pocket or bag.
- **Screensaver:** Set the device to launch a screensaver when the device is charging or connected to a dock.

## Always on display

You can set the device to display information, such as a clock, calendar, or image, on the screen when it is turned off.

- 1 On the Settings screen, tap **Display** → **Always on display** and tap the switch to activate it.
- 2 Tap **Content to show** and select an item to display.
  - **Clock:** Select a clock style and a background image.
  - **Calendar:** Select a calendar style.
  - **Image:** Select an image to display on the screen when it is turned off.

When the screen is off, the device will display the selected information.



This feature will be deactivated when the battery power drops below 5%.

## Advanced features

Activate advanced features and change the settings that control them.

On the Settings screen, tap **Advanced features**.



Excessive shaking or impact to the device may cause unintended input for some features.

- **Games:** Activate the Game Launcher and Game Tools icon and manage useful features while you play games. Refer to [Game Launcher](#) for more information.
- **One-handed operation:** Activate one-handed operation mode for your convenience when using the device with one hand.



This feature may not be available depending on the region or service provider.

- **Quick launch Camera:** Set the device to launch the camera by pressing the Home key twice quickly.

- **Pop-up view gesture:** Set the device to view the app screen in the pop-up view. Refer to [Pop-up view](#) for more information.
- **Smart capture:** Set the device to capture content that continues across multiple screens, and crop and share the screenshot immediately. Refer to [Smart capture](#) for more information.
- **Palm swipe to capture:** Set the device to capture a screenshot when you swipe your hand to the left or right across the screen. You can view the captured images in **Gallery**.



It is not possible to capture a screenshot while using some apps and features.

- **Direct call:** Set the device to make a voice call by picking up and holding the device near your ear while viewing call, message, or contact details.
- **Smart alert:** Set the device to alert you if you have missed calls or new messages when you pick up the device.



This feature may not work if the screen is turned on or the device is not on a flat surface.

- **Easy mute:** Set the device to mute incoming calls or alarms by using palm motions or facing the device's screen downwards.
- **Galaxy Labs:** Try experimental features.

## Wallpaper

Change the wallpaper settings for the Home screen and the locked screen.

On the Settings screen, tap **Wallpaper**.

## Themes

Apply various themes to the device to change the visual elements of the Home screen, locked screen, and icons.

On the Settings screen, tap **Themes**.

To download more themes, tap **MORE THEMES**.

## Home screen

Customise the Home screen by adding, deleting, or rearranging Home screen panels, and more. Refer to [Home screen options](#) for more information.

On the Settings screen, tap **Home screen**.

## Lock screen and security

### Options

Change the settings for securing the device and the SIM or USIM card.

On the Settings screen, tap **Lock screen and security**.



The available options may vary depending on the screen lock method selected.

- **Screen lock type:** Change the screen lock method.
- **Info and app shortcuts:** Change settings for the items displayed on the locked screen.
- **Notifications on lock screen:** Set whether or not to show notification content on the locked screen and select which notifications to display.

- **Secure lock settings:** Change screen lock settings for the selected lock method.
- **Fingerprints:** Register your fingerprint to the device to secure the device or sign in to your Samsung account. Refer to [Fingerprint recognition](#) for more information.
- **Find My Mobile:** Activate or deactivate the Find My Mobile feature. Access the Find my mobile website ([findmymobile.samsung.com](http://findmymobile.samsung.com)) to track and control your lost or stolen device.
- **Unknown sources:** Set the device to allow the installation of apps from unknown sources.
- **Protect encrypted data:** Your device's data is encrypted to prevent others from accessing it if the device is lost or stolen. To use your encrypted device, you must decrypt the device's data every time you turn on the device. You can set whether your device's data will be decrypted automatically or whether an unlock code is required. It is not possible to back up or restore data when it is encrypted. If you enter the unlock code incorrectly several times in a row and reach the attempt limit, your device will perform a factory data reset.
- **Encrypt SD card:** Set the device to encrypt files on a memory card.



If you reset your device to the factory defaults with this setting enabled, the device will not be able to read your encrypted files. Disable this setting before resetting the device.

- **Other security settings:** Configure additional security settings.

## Fingerprint recognition

In order for fingerprint recognition to function, your fingerprint information needs to be registered and stored in your device. After registering, you can set the device to use your fingerprint for the features below:

- Screen lock
- Web sign-in
- Verify Samsung account
- Samsung Pay



- This feature may not be available depending on the region or service provider.
- Fingerprint recognition uses the unique characteristics of each fingerprint to enhance the security of your device. The likelihood of the fingerprint sensor confusing two different fingerprints is very low. However, in rare cases where separate fingerprints are very similar the sensor may recognise them as identical.
- If you use your fingerprint as a screen lock method, your fingerprint cannot be used to unlock the screen after restarting the device. You must unlock the device using a pattern, PIN, or password you set when registering the fingerprint.
- If your fingerprint is not recognised, you must take the device to a Samsung Service Centre to have it reset. Then, you must re-register your fingerprints.

## For better fingerprint recognition

When you scan your fingerprints on the device, be aware of the following conditions that may affect the feature's performance:

- The Home key contains a fingerprint recognition sensor. Ensure that the Home key is not scratched or damaged by metal objects, such as coins, keys, and necklaces.
- The screen protector supplied with the device may cause the fingerprint recognition sensor to malfunction. Remove the screen protector to improve fingerprint sensitivity.
- Ensure that the fingerprint recognition area and your fingers are clean and dry.
- The device may not recognise fingerprints that are affected by wrinkles or scars.
- The device may not recognise fingerprints from small or thin fingers.
- If you bend your finger or use a fingertip, the device may not recognise your fingerprints. Make sure to cover the entire Home key with your finger.
- To improve recognition performance, register fingerprints of the hand used most often to perform tasks on the device.
- In dry environments, static electricity can build up in the device. Avoid using this feature in dry environments or before using the feature, discharge static electricity by touching a metal object.

## Registering fingerprints

- 1 On the Settings screen, tap **Lock screen and security** → **Fingerprints**.
- 2 Unlock the screen using the preset screen lock method.  
If you have not set a screen lock method, create one.
- 3 Tap **Add fingerprint**.
- 4 Place your finger on the Home key.
- 5 After the device detects your finger, lift it up and place it on the Home key again.  
Repeat this action by moving your finger upwards or downwards until the fingerprint is registered.  
When a fingerprint lock pop-up window appears, tap **ENABLE** to use your fingerprint to unlock the screen.

## Deleting fingerprints

You can delete registered fingerprints.

- 1 On the Settings screen, tap **Lock screen and security** → **Fingerprints**.
- 2 Unlock the screen using the preset screen lock method.
- 3 Tap **EDIT**.
- 4 Tick fingerprints to delete and tap **REMOVE**.

## Verifying the Samsung account password

Use fingerprints to verify your Samsung account password. You can use a fingerprint instead of entering your password, for example, when you purchase content from **Galaxy Apps**.

- 1 On the Settings screen, tap **Lock screen and security** → **Fingerprints**.
- 2 Unlock the screen using the preset screen lock method.

- 3 Tap the **Verify Samsung account** switch to activate it.
- 4 Sign in to your Samsung account.

## Using fingerprints to sign in to accounts

You can use your fingerprints to sign in to webpages that support password saving.



This feature is only available for webpages that you access via the **Internet** app.

- 1 On the Settings screen, tap **Lock screen and security** → **Fingerprints**.
- 2 Unlock the screen using the preset screen lock method.
- 3 Tap the **Web sign-in** switch to activate it.
- 4 Open a webpage that you want to sign in to with a fingerprint.
- 5 Enter your user name and password, and then tap the webpage's sign in button.
- 6 Tick **Sign in using your fingerprints** and tap **REMEMBER**.

You can use your fingerprint to verify your account and password to sign in to the webpage.

## Using fingerprints with Samsung Pay

You can use fingerprints with Samsung Pay to make payments quickly and securely. Refer to [Samsung Pay](#) for more information.



Samsung Pay may not be available depending on the region or service provider.

## Unlocking the screen with fingerprints

You can unlock the screen with your fingerprint instead of using a pattern, PIN, or password.

- 1 On the Settings screen, tap **Lock screen and security** → **Fingerprints**.
- 2 Unlock the screen using the preset screen lock method.
- 3 Tap the **Fingerprint unlock** switch to activate it.
- 4 On the locked screen, place your finger on the Home key and scan your fingerprint.

## Privacy and safety

### Options

Change the settings for maintaining your privacy and safety.

On the Settings screen, tap **Privacy and safety**.

- **Location:** Change settings for location information permissions.
- **App permissions:** View the list of features and apps that have permission to use them. You can also edit the permission settings. Refer to [Setting app permissions](#) for more information.
- **Private mode:** Activate private mode to prevent others from accessing your personal content. Refer to [Private mode](#) for more information.
- **Report diagnostic info:** Set the device to automatically send the device's diagnostic and usage information to Samsung.
- **Send SOS messages:** Set the device to send help messages by pressing the Power key three times. You can also send sound recordings along with the message to the recipients. Refer to [Send SOS messages](#) for more information.

## Private mode

Hide personal content in your device to prevent others from accessing it.

### Activating private mode

- 1 On the Settings screen, tap **Privacy and safety** → **Private mode**, and then tap the switch to activate it.

If you are activating private mode for the first time, follow the on-screen instructions to set up a private mode access code.

- 2 Follow the on-screen instructions to enter the preset private mode access code.

Private mode is activated and the  icon appears on the status bar.



You can view and access the hidden items only when private mode is activated. To hide items stored in the private folder, deactivate private mode.

### Hiding content

- 1 On the Apps screen, launch an app to hide items.

- 2 Select an item and tap **MORE** → **Move to Private**.

If private mode is not activated, follow the on-screen instructions to enter the preset private mode access code.

The selected items will be moved to the private folder.

## Viewing hidden content

You can view hidden items only when private mode is activated.

- 1 On the Settings screen, tap **Privacy and safety** → **Private mode**, and then tap the switch to activate it.
- 2 Follow the on-screen instructions to enter the preset private mode access code.
- 3 On the Apps screen, tap **Samsung** → **My Files** → **Private**.  
Items moved to the private folder will appear on the screen.

## Unhiding content

- 1 In the private folder, tap and hold an item to, and then then tick items to unhide.
- 2 Tap **MORE** → **Remove from Private**.
- 3 Select a folder to move the items to, and then tap **DONE**.  
The items will be moved to the selected folder.

## Automatically deactivating private mode

You can set the device to automatically deactivate private mode each time the screen turns off.

- 1 On the Settings screen, tap **Privacy and safety** → **Private mode**, and then tap the switch to activate it.
- 2 Follow the on-screen instructions to enter the preset private mode access code.
- 3 Tap the **Auto disable** switch to activate it.



When the **Auto disable** option is enabled, the device will fail to transfer files to the private folder if the screen turns off during transfer.

## Send SOS messages

In an emergency situation, quickly press the Power key three times. The device sends messages to your emergency contacts. The messages include your location information.

- 1 On the Settings screen, tap **Privacy and safety** → **Send SOS messages**, and then tap the switch to activate it.
- 2 Follow the on-screen instructions to add emergency contacts if you have not already done so.

To send help messages with audio recordings or photos, tap the **Attach audio recording** or **Attach pictures** switch to activate it.



The **Attach pictures** option may not be available depending on the region or service provider.

## Adding emergency contacts

On the Settings screen, tap **Privacy and safety** → **Send SOS messages** → **Send messages to** → **ADD**. Tap **Create contact** and enter contact information or tap **Select from contacts** to add an existing contact as an emergency contact.

## Easy mode

Easy mode provides an easier user experience by using a simpler layout and bigger icons on the Home screen.



Some app features may not be available in easy mode.

### Switching to easy mode

- 1 On the Settings screen, tap **Easy mode** → **Easy mode**.
- 2 Select apps under **Easy applications** to apply a simpler layout.
- 3 Tap **DONE**.

### Returning to standard mode

Swipe to the left on the Home screen and tap **Settings** → **Easy mode** → **Standard mode** → **DONE**.

### Managing shortcuts

To add a shortcut to an app to the Home screen, swipe to the left, tap , and then select an app.

To add a shortcut to a contact on the Home screen, swipe to the right and tap .

To delete a shortcut from the Home screen, tap **EDIT** and select an app or contact with .

## Accessibility

Configure various settings to improve accessibility to the device. Refer to [Accessibility](#) for more information.

On the Settings screen, tap **Accessibility**.

## Accounts

Add your Samsung and Google accounts, or other accounts, to sync with.

### Adding accounts

Some apps used on your device require a registered account. Create accounts to have the best experience with your device.

- 1 On the Settings screen, tap **Accounts** → **Add account**.
- 2 Select an account service.
- 3 Follow the on-screen instructions to complete the account setup.

To sync content with your accounts, select an account and select items to sync.

### Removing accounts

On the Settings screen, tap **Accounts**, select an account name, select the account to remove, and then tap **MORE** → **Remove account**.

## Backup and reset

Change the settings for managing settings and data.

On the Settings screen, tap **Backup and reset**.

- **Open Smart Switch:** Launch **Smart Switch** and transfer data from your previous device. Refer to [Transferring data from your previous device](#) for more information.
- **Back up my data:** Back up your personal information and app data to the Samsung server. You can also set the device to automatically back up data.
- **Restore:** Restore previously backed up personal information and app data from your Samsung account.

- **Back up my data:** Set the device to back up settings and app data to the Google server.
- **Backup account:** Set up or edit your Google backup account.
- **Automatic restore:** Set the device to automatically restore settings and app data from the Google server when apps are reinstalled.
- **Auto restart:** Set the device to restart itself at preset times for optimal performance.
- **Reset settings:** Return the device's settings to the factory default settings without deleting data.
- **Reset network settings:** Return the network connection settings to the factory default settings.
- **Factory data reset:** Return the device to the factory default settings and delete all data.

## Language and input

Select device languages and change settings, such as keyboards and voice input types. Some options may not be available depending on the selected language.

On the Settings screen, tap **Language and input**.

- **Language:** Select a display language for all menus and apps.
- **Default keyboard:** Select a default keyboard type for text input.
- **Samsung keyboard:** Change the Samsung keyboard settings.
- **Google voice typing:** Change the voice input settings.
- **Text-to-speech:** Change the text-to-speech settings.
- **Pointer speed:** Adjust the pointer speed for the mouse or trackpad connected to your device.

## Battery

View battery power information and change power saving options.

On the Settings screen, tap **Battery**.



The usage time left shows the time remaining before the battery power runs out. Usage time left may vary depending on your device settings and operating conditions.

- **BATTERY USAGE:** View the amount of battery power consumed by your device.
- **Power saving mode:** Activate power-saving mode and change the settings for power-saving mode. Refer to [Power saving mode](#) for more information.
- **Ultra power saving mode:** Extend standby time and reduce battery consumption by displaying a simpler layout and allowing limited access to an app. Refer to [Ultra power saving mode](#) for more information.
- **App power saving:** Save battery power by optimising the battery usage for each app.
- **Percentage on status bar:** Set the device to display the remaining battery life.
- **Fast cable charging:** Set whether to use the fast cable charging feature to charge your device quickly.
- **Fast wireless charging:** Set whether to use the fast wireless charging feature. When this feature is activated, noise may occur from the wireless charger. Deactivating this feature will reduce noise, but may result in slower charging times.



This option will appear when you place your device on a wireless charger that supports the fast wireless charging feature.

## Storage

View memory information for your device.

On the Settings screen, tap **Storage**.



The actual available capacity of the internal memory is less than the specified capacity because the operating system and default apps occupy part of the memory. The available capacity may change when you update the device.

## Date and time

Access and alter the following settings to control how the device displays the time and date.

On the Settings screen, tap **Date and time**.



If the battery remains fully discharged or removed from the device, the time and date is reset.

- **Automatic date and time:** Automatically update the time and date when moving across time zones. When this feature is deactivated, you can manually set the date, time, and time zone.
- **Use 24-hour format:** Display time in 24-hour format.

## User manual

View help information to learn how to use the device and apps or configure important settings.

On the Settings screen, tap **User manual**.

## About device

Access device information, edit the device name, or update device software.

On the Settings screen, tap **About device**.

# Appendix

## Accessibility

### About Accessibility

Improve accessibility with features that make the device easier to use for users who have impaired vision, hearing, and reduced dexterity.

On the Apps screen, tap **Settings** → **Accessibility**.

### Using the Home key to open accessibility menus

On the Apps screen, tap **Settings** → **Accessibility** → **Direct access**, and then tap the switch to activate it. Then, select an accessibility menu to open when you press the Home key three times quickly.

You can access the following accessibility menus.

- Accessibility
- Voice Assistant
- Universal switch
- Magnifier window
- Negative colours
- Greyscale
- Colour adjustment
- Interaction control

## Voice Assistant (Voice feedback)

### Activating or deactivating Voice Assistant

When you activate Voice Assistant, the device will start voice feedback. When you tap the selected feature once, the device will read the text on the screen aloud. Tapping the feature twice will activate the feature.

On the Apps screen, tap **Settings** → **Accessibility** → **Vision** → **Voice Assistant**, and then tap the switch to activate it.

To deactivate Voice Assistant, tap the switch and tap anywhere on the screen twice quickly.

When you activate Voice Assistant for the first time, the tutorial will start after activation. You can replay it by tapping **Voice Assistant help**.



Some features are not available while you are using Voice Assistant.

### Controlling the screen with finger gestures

You can use various finger gestures to control the screen while you are using Voice Assistant.

#### One finger gestures

- Tapping: Read aloud the item under your finger. To explore the screen, place a finger on the screen and move it on the screen.
- Tapping twice: Open the selected item. While selected items are read aloud, when you hear the item you want, release your finger from the item. Then, tap anywhere on the screen twice quickly.
- Double-tapping and holding the screen: Move an item or access an available option.
- Swiping to the left: Move to the previous item.
- Swiping to the right: Move to the next item.
- Swiping upwards or downwards: Change the most recent contextual menu settings. In text selection mode, move the cursor backwards or forwards to select text.

- Swiping to the left then right in one motion: Scroll up the screen.
- Swiping to the right then left in one motion: Scroll down the screen.
- Swiping upwards then downwards in one motion: Move to the first item on the screen. In text selection mode, move the cursor to the beginning of the text.
- Swiping downwards then upwards in one motion: Move to the last item on the screen. In text selection mode, move the cursor to the end of the text.

### **Two finger gestures**

- Tapping: Pause or resume voice feedback.
- Tapping twice: Start, pause, or resume playback.
- Tapping three times: Check the current time, remaining battery power, and more. To change items that are read aloud, open the Apps screen and tap **Settings** → **Accessibility** → **Vision** → **Voice Assistant** → **SETTINGS** → **Status bar information**.
- Double-tapping and holding the screen: Enable or disable text selection mode.
- Swiping to the left: Move to the next page. In text selection mode, cut the selected text.
- Swiping to the right: Return to the previous page. In text selection mode, paste the copied text.
- Swiping upwards: Scroll down the list. In text selection mode, copy the selected text.
- Swiping downwards: Scroll up the list. In text selection mode, select all text.
- Swiping in any direction on the locked screen: Unlock the screen.
- Swiping downwards from the top of the screen: Open the notification panel.

### **Three finger gestures**

- Tapping: Start reading items aloud from the top.
- Tapping twice: Start reading from the next item.
- Tapping three times: Read the last selected text and copy it to the clipboard.
- Swiping to the left or right: Open the contextual menu and scroll through the options.
- Swiping upwards or downwards: Change the text reading and selecting granularity.

## Using the contextual menu

While you are using Voice Assistant, swipe to the left or right with three fingers. The contextual menu will appear and the device will read the options aloud. Swipe to the left or right with three fingers to scroll through the options. When you hear the option you want, swipe upwards or downwards to use the option or adjust the settings for the option. For example, when you hear **Device volume**, you can adjust the volume by swiping upwards or downwards.

## Adding and managing image labels

You can assign labels to images on the screen. The device reads aloud the labels when the images are selected. Add labels to unlabelled images by tapping the screen twice with three fingers and holding.

To manage the labels, open the Apps screen and tap **Settings** → **Accessibility** → **Vision** → **Voice Assistant** → **SETTINGS** → **Manage customised labels**.

## Configuring settings for Voice Assistant

Configure settings for Voice Assistant for your convenience.

On the Apps screen, tap **Settings** → **Accessibility** → **Vision** → **Voice Assistant** → **SETTINGS**.

- **Speech volume:** Select the volume level for voice feedback.
- **Speech rate:** Select a speed for voice feedback.
- **Pitch changes:** Set the device to read aloud text with an altered pitch while using a keyboard.
- **Keyboard feedback:** Set the device to read aloud the item under your finger while using a keyboard.
- **Speak while screen off:** Set the device to read aloud notifications when the screen is turned off.
- **Use proximity sensor:** Set the device to pause voice feedback when you place your hand over the sensor at the top of the device.
- **Shake to continue reading:** Set the device to read aloud the text displayed on the screen when you shake the device. You can select from various shaking speeds.

- **Read out phonetic alphabet:** Set the device to say a word that starts with the letter you tap and hold on the keyboard.
- **Read out usage hints:** Set the device to read usage hints aloud when you select an item by swiping.
- **Vibration feedback:** Set the device to vibrate when you explore the screen.
- **Sound feedback:** Set the device to emit a sound when you control the screen, such as scrolling the screen, and more.
- **Focus on speech audio:** Set the device to turn the media volume down when the device reads an item aloud.
- **Sound feedback volume:** Adjust the volume that sound is played when you touch the screen to control it. This feature is available when **Sound feedback** is activated.
- **Large cursor:** Set the device to thicken the border of the square cursor that appears when you tap items.
- **Back and Recents key feedback:** Set the device to provide voice feedback when you tap  or  once. Double-tap  or  to use the keys.
- **Quick menu:** Select contextual menu options to display when you swipe to the left or right with three fingers.
- **Manage customised labels:** Manage the labels you added.
- **Status bar information:** Select items to read aloud when you tap the screen three times with two fingers.
- **Developer options:** Set options for app development.

## Using the device with the screen turned off

For privacy, you can set the device to function normally with the screen off. The screen does not turn on when you press the Home key or tap the screen. Currently activated features do not turn off when the screen is off.

On the Apps screen, tap **Settings** → **Accessibility** → **Vision**, and then tap the **Dark screen** switch to activate it. You can activate or deactivate this feature by pressing the Power key twice.

## Reading passwords aloud

Set the device to read the password aloud when you enter the password while Voice Assistant is activated.

On the Apps screen, tap **Settings** → **Accessibility** → **Vision**, and then tap the **Speak passwords** switch to activate it.

## Setting text-to-speech features

Change the settings for text-to-speech features used when Voice Assistant is activated, such as languages, speed, and more.

On the Apps screen, tap **Settings** → **Accessibility** → **Vision** → **Text-to-speech**, and then use the following functions:

- **Preferred TTS engine:** Select an engine for the text-to-speech feature.
- **Speech rate:** Adjust the speed for the text-to-speech feature.
- **Default language status:** View the spoken language of the text-to-speech feature.

## Entering text using the keyboard

To display the keyboard, tap the text input field, and then tap anywhere on the screen twice quickly.

To activate the rapid key input feature, open the Apps screen, tap **Settings** → **Accessibility** → **Vision**, and then tap the **Rapid key input** switch to activate it.

When you touch the keyboard with your finger, the device reads aloud the character keys under your finger. When you hear the character you want, release your finger from the screen to select it. The character is entered and the device reads the text aloud.

If **Rapid key input** is not activated, release your finger from the character you want, and then tap anywhere on the screen twice quickly.

## Entering additional characters

Tap and hold a key on the keyboard to enter additional characters available for the key. A pop-up window appears above the key showing available characters. To select a character, drag your finger on the pop-up window until you hear the character you want, and release it.

## Vision

### Adding voice recordings to voice labels

You can use voice labels to distinguish objects of similar shape by attaching labels to them. You can record and assign a voice recording to an NFC-enabled voice label. The voice recording is played back when you place your device near the label.



Turn on the NFC feature before using this feature.

- 1 On the Apps screen, tap **Settings** → **Accessibility** → **Vision** → **Voice Label**.  
The voice recorder will launch.
- 2 Tap  to start recording. Speak into the microphone.
- 3 When you are finished recording, tap **DONE** to stop.
- 4 Hold the back of your device over the voice label.  
The information in the voice recording will be written to the voice label.

### Changing the font size

Change the font size displayed on the screen.

On the Apps screen, tap **Settings** → **Accessibility** → **Vision** → **Font size**.

To use larger font sizes, tap the **Larger font sizes** switch to activate it and drag the adjustment bar to change the font size. When you set the font size to **Extra huge**, the font size may not be applied to some apps.

### Using the high contrast font

Adjust the colour and outline of fonts to increase the contrast between the text and the background.

On the Apps screen, tap **Settings** → **Accessibility** → **Vision** and tap the **High contrast fonts** switch to activate it.

## Using the high contrast keyboard

Increase the size of the Samsung keyboard and change the key colours to increase the contrast between the text and the background.

On the Apps screen, tap **Settings** → **Accessibility** → **Vision**, and then tap the **High contrast keyboard** switch to activate it.

## Displaying button shapes

Display button shapes with shaded backgrounds to make them stand out.

On the Apps screen, tap **Settings** → **Accessibility** → **Vision**, and then tap the **Show button shapes** switch to activate it.

## Using a magnifier

Activate a magnifier to zoom in on the screen to view a larger version of the content.

On the Apps screen, tap **Settings** → **Accessibility** → **Vision** → **Magnifier window**, and then tap the switch to activate it. The magnifier will appear on the screen.

Drag the magnifier to where you want to zoom in on the screen.

## Magnifying the screen

Magnify the screen and zoom in on a specific area.

On the Apps screen, tap **Settings** → **Accessibility** → **Vision** → **Magnification gestures**, and then tap the switch to activate it.

- Zooming in and out: Quickly tap the screen three times to zoom in on a specific area. Quickly tap the screen three times again to return to the normal view.
- Exploring the screen by scrolling: Drag two or more fingers across the magnified screen.
- Adjusting zoom ratio: Pinch two or more fingers on the magnified screen or spread them apart.

You can also temporarily magnify the screen by tapping the screen three times and holding. While holding the screen, drag your finger to explore the screen. Release your finger to return to the normal view.



- Keyboards on the screen cannot be magnified.
- When this feature is activated, the performance of some apps, such as **Phone** and **Calculator**, may be affected.

## Converting the screen to greyscale mode

Display colours on the screen as grey tones.

On the Apps screen, tap **Settings** → **Accessibility** → **Vision**, and then tap the **Greyscale** switch to activate it.

## Reversing the display colours

Improve screen visibility to help users recognise text on the screen more easily.

On the Apps screen, tap **Settings** → **Accessibility** → **Vision**, and then tap the **Negative colours** switch to activate it.

## Colour adjustment

Adjust how colours are displayed on the screen if you have difficulty in distinguishing colours. The device changes the colours into more recognisable colours.

On the Apps screen, tap **Settings** → **Accessibility** → **Vision** → **Colour adjustment**, and then tap the switch to activate it. Follow the on-screen instructions to complete the colour adjustment procedure.

## Hearing

### Sound detectors

Set the device to vibrate when it detects your doorbell or a baby crying.



While you are using voice recognition, such as **S Voice**, the sound detectors will not operate.

### Baby crying detector

On the Apps screen, tap **Settings** → **Accessibility** → **Hearing** → **Sound detectors**, and then tap the **Baby crying detector** switch to activate it. The device will vibrate when it detects sound and the alert will be saved as a log.

## Doorbell detector

- 1 On the Apps screen, tap **Settings** → **Accessibility** → **Hearing** → **Sound detectors**, and then tap the **Doorbell detector** switch to activate it.
- 2 Tap  to make a recording of your doorbell.  
The device will detect and record the doorbell.
- 3 Tap  and ring your doorbell to check if it is recorded correctly. When the device detects the doorbell sound, tap **OK**.  
To change the doorbell sound, tap **Change doorbell sound**.  
The device will vibrate when it detects sound and the alert will be saved as a log.

## Setting flash notification

Set the flash to blink when an alarm sounds or when you have notifications, such as incoming calls and new messages.

On the Apps screen, tap **Settings** → **Accessibility** → **Hearing**, and then tap the **Flash notification** switch to activate it.

## Turning off all sounds

Set the device to mute all device sounds, such as media sounds, and the caller's voice during a call.

On the Apps screen, tap **Settings** → **Accessibility** → **Hearing**, and then tap the **Turn off all sounds** switch to activate it.

## Caption settings

On the Apps screen, tap **Settings** → **Accessibility** → **Hearing** → **Samsung subtitles (CC)** or **Google subtitles (CC)**, and then tap the switch to activate it.

Select an option for configuring the caption settings.

## Adjusting the sound balance

Set the device to adjust the sound balance when using a headset.

- 1 Connect a headset to the device and wear it.
- 2 On the Apps screen, tap **Settings** → **Accessibility** → **Hearing**.
- 3 Drag the adjustment bar under **Left/right sound balance** to the left or right and adjust the sound balance.

## Mono audio

Mono output combines stereo sound into one signal that is played through all headset speakers. Use this if you have a hearing impairment or if a single earbud is more convenient.

On the Apps screen, tap **Settings** → **Accessibility** → **Hearing**, and then tap the **Mono audio** switch to activate it.

## Dexterity and interaction

### Universal switch

You can control the touchscreen by connecting an external switch, by tapping the screen, or by using head movements and face gestures.

On the Apps screen, tap **Settings** → **Accessibility** → **Dexterity and interaction** → **Universal switch**, and then tap the switch to activate it. If the universal switches are not registered on the device, tap **ADD SWITCH** and set switches to control the device.



To activate the universal switch feature, at least one switch must be registered on the device.

To set switches to control the device, tap **SETTINGS** → **Switches**.

To deactivate this feature, press the Home key three times.

## Assistant menu

### Displaying the assistive shortcut icon

Set the device to display the assistive shortcut icon for accessing apps, features, and settings. You can easily control the device by tapping the assistive menus in the icon.

- 1 On the Apps screen, tap **Settings** → **Accessibility** → **Dexterity and interaction** → **Assistant menu**.
- 2 Tap the switch to activate it.  
The assistive shortcut icon appears at the bottom right of the screen.
- 3 Tap **Dominant hand** to move the assistive shortcut icon to a convenient location.

### Accessing assistive menus

The assistive shortcut icon appears as a floating icon for easy access to the assistive menus from any screen.

When you tap the assistive shortcut icon, the icon expands slightly and the assistive menus appear on the icon. Tap the up or down arrow to move to other panels or swipe upwards or downwards to select other menus.

### Using the cursor

On the assistive menu, tap **Cursor**. You can control the screen using small finger movements on the touch area. Drag your finger on the touch area to move the cursor. Also, tap the screen to select items under the cursor.

Use the following options:

- : Scroll left or right on the screen.
- : Scroll up or down the screen.
- : Magnify the area where the cursor is located.
- : Move the touch area to another location.
- : Close the touch area.

To change the touch area and cursor settings, open the Apps screen, tap **Settings** → **Accessibility** → **Dexterity and interaction** → **Assistant menu**. Then, customise settings in **Touchpad and cursor settings**.

### Using enhanced assistive menus

Set the device to display enhanced assistive menus for selected apps.

On the Apps screen, tap **Settings** → **Accessibility** → **Dexterity and interaction** → **Assistant menu** → **Assistant plus**, tap the switch to activate it, and then select apps.

### Easy screen turn on

Turn on the screen by moving your hand above the sensor at the top of the device. You can turn on the screen without pressing a key. When you use this feature, place the device on a flat surface with the screen facing upwards or hold the device securely to prevent it from moving.

On the Apps screen, tap **Settings** → **Accessibility** → **Dexterity and interaction** → **Easy screen turn on**, and then tap the switch to activate it.

### Tap and hold delay

Set the recognition time for tapping and holding the screen.

On the Apps screen, tap **Settings** → **Accessibility** → **Dexterity and interaction** → **Tap and hold delay**, and then select an option.

### Interaction control

Activate interaction control mode to restrict the device's reaction to inputs while using apps.



This feature is not available when you activate **Palm swipe to capture**, **Direct call**, **Smart alert**, or **Easy mute**.

1 On the Apps screen, tap **Settings** → **Accessibility** → **Dexterity and interaction** → **Interaction control**.

- 2 Tap the switch to activate it.
- 3 Press and hold the Home key and the Volume key down simultaneously while using an app.
- 4 Adjust the size of the frame or draw a line around an area that you want to restrict.
- 5 Tap **DONE**.

The device displays the restricted area. The restricted area will not react when you touch it and the device's hard keys will be disabled. However, you can enable functions for the Power key, Volume key, and keyboard in interaction control mode.

To deactivate interaction control mode, press and hold the Home key and the Volume key down simultaneously.

## Direction lock

Create a directional combination to unlock the screen.

- 1 On the Apps screen, tap **Settings** → **Accessibility** → **Direction lock** and tap the switch to activate it.
- 2 Drag your finger up, down, left, or right more than four times, and then tap **CONTINUE**.
- 3 Draw the direction combination again to verify it and tap **CONFIRM**.

## Notification reminder

Set the device to alert you to notifications that you have not checked at the interval.

On the Apps screen, tap **Settings** → **Accessibility** → **Notification reminder**, and then tap the switch to activate it.

To set the device to vibrate when you have unchecked notifications, tap the **Vibrate** switch to activate it.

To set an interval between alerts, tap **Reminder interval**.

To set apps to alert you to notifications, select apps under **Show Notifications from**.

## Answering or ending calls

Change the method of answering or ending calls.

On the Apps screen, tap **Settings** → **Accessibility** → **Answering and ending calls**.

Select the desired method.

## Using single tap mode

When an alarm sounds or a call comes in, tap the button to stop the alarm or answer the call instead of dragging the button.

On the Apps screen, tap **Settings** → **Accessibility**, and then tap the **Single tap mode** switch to activate it.

## Managing accessibility settings

### Saving accessibility settings in a file

Export the current accessibility settings in a file.

On the Apps screen, tap **Settings** → **Accessibility** → **Manage accessibility** → **Import/Export** → **Export to My Files**.

### Importing an accessibility settings file

Import an accessibility settings file and update the current settings.

On the Apps screen, tap **Settings** → **Accessibility** → **Manage accessibility** → **Import/Export** → **Import from My Files**. Select a file to import and tap **DONE**. The accessibility settings will be updated according to the imported file.

### Sharing accessibility settings files

Share accessibility settings files with others via email, Wi-Fi Direct, Bluetooth, and more.

On the Apps screen, tap **Settings** → **Accessibility** → **Manage accessibility** → **Share via**. Then, select the accessibility files and tap **DONE**. Select a sharing method and follow the on-screen instructions to share the files.

## Troubleshooting

Before contacting a Samsung Service Centre, please attempt the following solutions. Some situations may not apply to your device.

### When you turn on your device or while you are using the device, it prompts you to enter one of the following codes:

- **Password:** When the device lock feature is enabled, you must enter the password you set for the device.
- **PIN:** When using the device for the first time or when the PIN requirement is enabled, you must enter the PIN supplied with the SIM or USIM card. You can disable this feature by using the Lock SIM card menu.
- **PUK:** Your SIM or USIM card is blocked, usually as a result of entering your PIN incorrectly several times. You must enter the PUK supplied by your service provider.
- **PIN2:** When you access a menu requiring the PIN2, you must enter the PIN2 supplied with the SIM or USIM card. For more information, contact your service provider.

### Your device displays network or service error messages

- When you are in areas with weak signals or poor reception, you may lose reception. Move to another area and try again. While moving, error messages may appear repeatedly.
- You cannot access some options without a subscription. For more information, contact your service provider.

### Your device does not turn on

When the battery is completely discharged, your device will not turn on. Fully charge the battery before turning on the device.

## The touchscreen responds slowly or improperly

- If you attach a screen protector or optional accessories to the touchscreen, the touchscreen may not function properly.
- If you are wearing gloves, if your hands are not clean while touching the touchscreen, or if you tap the screen with sharp objects or your fingertips, the touchscreen may malfunction.
- The touchscreen may malfunction in humid conditions or when exposed to water.
- Restart your device to clear any temporary software bugs.
- Ensure that your device software is updated to the latest version.
- If the touchscreen is scratched or damaged, visit a Samsung Service Centre.

## Your device freezes or encounters a fatal error

Try the following solutions. If the problem is still not resolved, contact a Samsung Service Centre.

### Restarting the device

If your device freezes or hangs, you may need to close apps or turn off the device and turn it on again.

### Forcing restart

If your device is frozen and unresponsive, press and hold the Power key and the Volume Down key simultaneously for more than 7 seconds to restart it.

### Resetting the device

If the methods above do not solve your problem, perform a factory data reset.

On the Apps screen, tap **Settings** → **Backup and reset** → **Factory data reset** → **RESET DEVICE** → **ERASE EVERYTHING**. Before performing the factory data reset, remember to make backup copies of all important data stored in the device.

## **Calls are not connected**

- Ensure that you have accessed the right cellular network.
- Ensure that you have not set call barring for the phone number you are dialling.
- Ensure that you have not set call barring for the incoming phone number.

## **Others cannot hear you speaking on a call**

- Ensure that you are not covering the built-in microphone.
- Ensure that the microphone is close to your mouth.
- If using a headset, ensure that it is properly connected.

## **Sound echoes during a call**

Adjust the volume by pressing the Volume key or move to another area.

## **A cellular network or the Internet is often disconnected or audio quality is poor**

- Ensure that you are not blocking the device's internal antenna.
- When you are in areas with weak signals or poor reception, you may lose reception. You may have connectivity problems due to issues with the service provider's base station. Move to another area and try again.
- When using the device while moving, wireless network services may be disabled due to issues with the service provider's network.

## **The battery icon is empty**

Your battery is low. Charge the battery.

## The battery does not charge properly (For Samsung-approved chargers)

- Ensure that the charger is connected properly.
- Visit a Samsung Service Centre and have the battery replaced.

## The battery depletes faster than when first purchased

- When you expose the device or the battery to very cold or very hot temperatures, the useful charge may be reduced.
- Battery consumption increases when you use messaging features or some apps, such as games or the Internet.
- The battery is consumable and the useful charge will get shorter over time.

## Your device is hot to the touch

When you use apps that require more power or use apps on your device for an extended period of time, your device may feel hot to the touch. This is normal and should not affect your device's lifespan or performance.

If the device overheats or feels hot for a prolonged period, do not use it for a while. If the device continues to overheat, contact a Samsung Service Centre.

## Error messages appear when launching the camera

Your device must have sufficient available memory and battery power to operate the camera app. If you receive error messages when launching the camera, try the following:

- Charge the battery.
- Free some memory by transferring files to a computer or deleting files from your device.
- Restart the device. If you are still having trouble with the camera app after trying these tips, contact a Samsung Service Centre.

## Photo quality is poorer than the preview

- The quality of your photos may vary, depending on the surroundings and the photography techniques you use.
- If you take photos in dark areas, at night, or indoors, image noise may occur or images may be out of focus.

## Error messages appear when opening multimedia files

If you receive error messages or multimedia files do not play when you open them on your device, try the following:

- Free some memory by transferring files to a computer or deleting files from your device.
- Ensure that the music file is not Digital Rights Management (DRM)-protected. If the file is DRM-protected, ensure that you have the appropriate licence or key to play the file.
- Ensure that the file formats are supported by the device. If a file format is not supported, such as DivX or AC3, install an app that supports it. To confirm the file formats that your device supports, visit [www.samsung.com](http://www.samsung.com).
- Your device supports photos and videos captured with the device. Photos and videos captured by other devices may not work properly.
- Your device supports multimedia files that are authorised by your network service provider or providers of additional services. Some content circulated on the Internet, such as ringtones, videos, or wallpapers, may not work properly.

## Another Bluetooth device is not located

- Ensure that the Bluetooth wireless feature is activated on your device.
- Ensure that the Bluetooth wireless feature is activated on the device you wish to connect to.
- Ensure that your device and the other Bluetooth device are within the maximum Bluetooth range (10 m).

If the tips above do not solve the problem, contact a Samsung Service Centre.

## **A connection is not established when you connect the device to a computer**

- Ensure that the USB cable you are using is compatible with your device.
- Ensure that you have the proper driver installed and updated on your computer.
- If you are a Windows XP user, ensure that you have Windows XP Service Pack 3 or higher installed on your computer.

## **Your device cannot find your current location**

GPS signals may be obstructed in some locations, such as indoors. Set the device to use Wi-Fi or a mobile network to find your current location in these situations.

## **Data stored in the device has been lost**

Always make backup copies of all important data stored in the device. Otherwise, you cannot restore data if it is corrupted or lost. Samsung is not responsible for the loss of data stored in the device.

## **A small gap appears around the outside of the device case**

- This gap is a necessary manufacturing feature and some minor rocking or vibration of parts may occur.
- Over time, friction between parts may cause this gap to expand slightly.

## **There is not enough space in the device's storage**

Delete unnecessary data, such as cache, using the Smart manager or manually delete unused apps or files to free up storage space.

## Removing the battery

- To remove the battery, you **must** visit an authorised service centre with the provided instructions.
- For your safety, you **must not attempt to remove** the battery. If the battery is not properly removed, it may lead to damage to the battery and device, cause personal injury, and/or result in the device being unsafe.
- Samsung does not accept liability for any damage or loss (whether in contract or tort, including negligence) which may arise from failure to precisely follow these warnings and instructions, other than death or personal injury caused by Samsung's negligence.

- 1 Remove the tray from the device.
- 2 To soften the adhesive that holds the back cover to the main device, the device must be warmed to a controlled level using a dedicated temperature controlled chamber.  
Attach a suction pad removal tool to the lower end of the back cover and while holding the device firmly, pull the back cover away from the bottom upwards.
- 3 Loosen and remove the screws at the location points and remove the chassis.
- 4 Disconnect the battery connector and gently lever the battery away from the main body of the unit.

## Copyright

Copyright © 2016 Samsung Electronics

This manual is protected under international copyright laws.

No part of this manual may be reproduced, distributed, translated, or transmitted in any form or by any means, electronic or mechanical, including photocopying, recording, or storing in any information storage and retrieval system, without the prior written permission of Samsung Electronics.

## Trademarks

- SAMSUNG and the SAMSUNG logo are registered trademarks of Samsung Electronics.
- Bluetooth® is a registered trademark of Bluetooth SIG, Inc. worldwide.
- Wi-Fi®, Wi-Fi Protected Setup™, Wi-Fi Direct™, Wi-Fi CERTIFIED™, and the Wi-Fi logo are registered trademarks of the Wi-Fi Alliance.
- All other trademarks and copyrights are the property of their respective owners.